



REFRIGERATION AND  
AIR CONDITIONING

# INSTRUCTIONS

## AK-CC 210



084R8006



R18MB253

084R8006

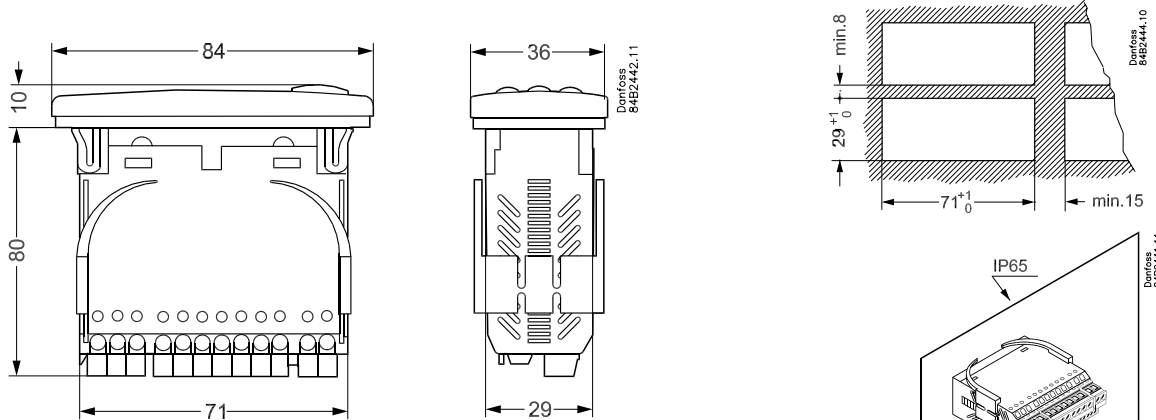

$t_{amb} = 0 - +55^{\circ}\text{C}$   
230 V a.c.  
2.5 VA

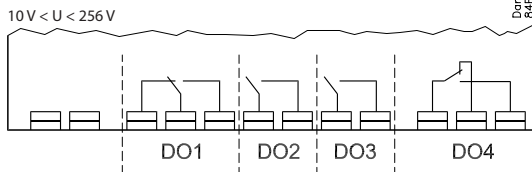

	CE (250 V a.c.)	UL *** (240 V a.c.)
DO1. Refrigeration *	10 (6) A	10 A Resistive 5FLA, 30LRA
DO2. Defrost *	10 (6) A	10 A Resistive 5FLA, 30LRA
DO3. Fan or refrigeration 2 *	6 (3) A	6 A Resistive 3FLA, 18LRA 131 VA Pilot duty
DO4. Alarm, light, rail heat or hotgas defrost *	4 (1) A Min. 100 mA**	4 A Resistive 131 VA Pilot duty

\* DO1 and DO2 are 16 A relays. DO3 and DO4 are 8 A relays. Max. load must be kept.  
\*\* Gold plating ensures make function with small contact loads  
\*\*\* UL-approval based on 30000 couplings

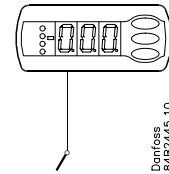
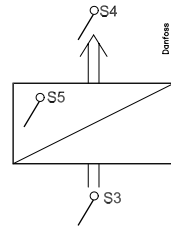

Type: Pt 1000 (1000  $\Omega$  /  $0^{\circ}\text{C}$ ) /  
Ptc 1000 (1000  $\Omega$  /  $25^{\circ}\text{C}$ ) /  
NTC-M2020 (5000  $\Omega$  /  $25^{\circ}\text{C}$ )

(o06)

084R8006

### Koordineret afrimning Coordinated defrost

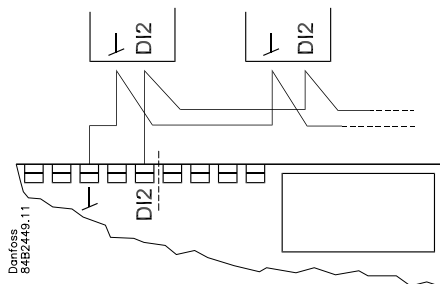

### Data communication LON RS485:

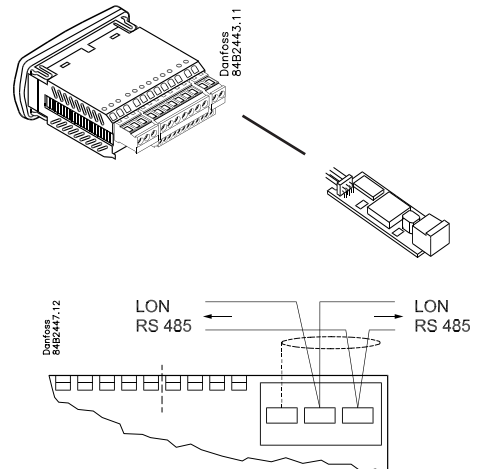

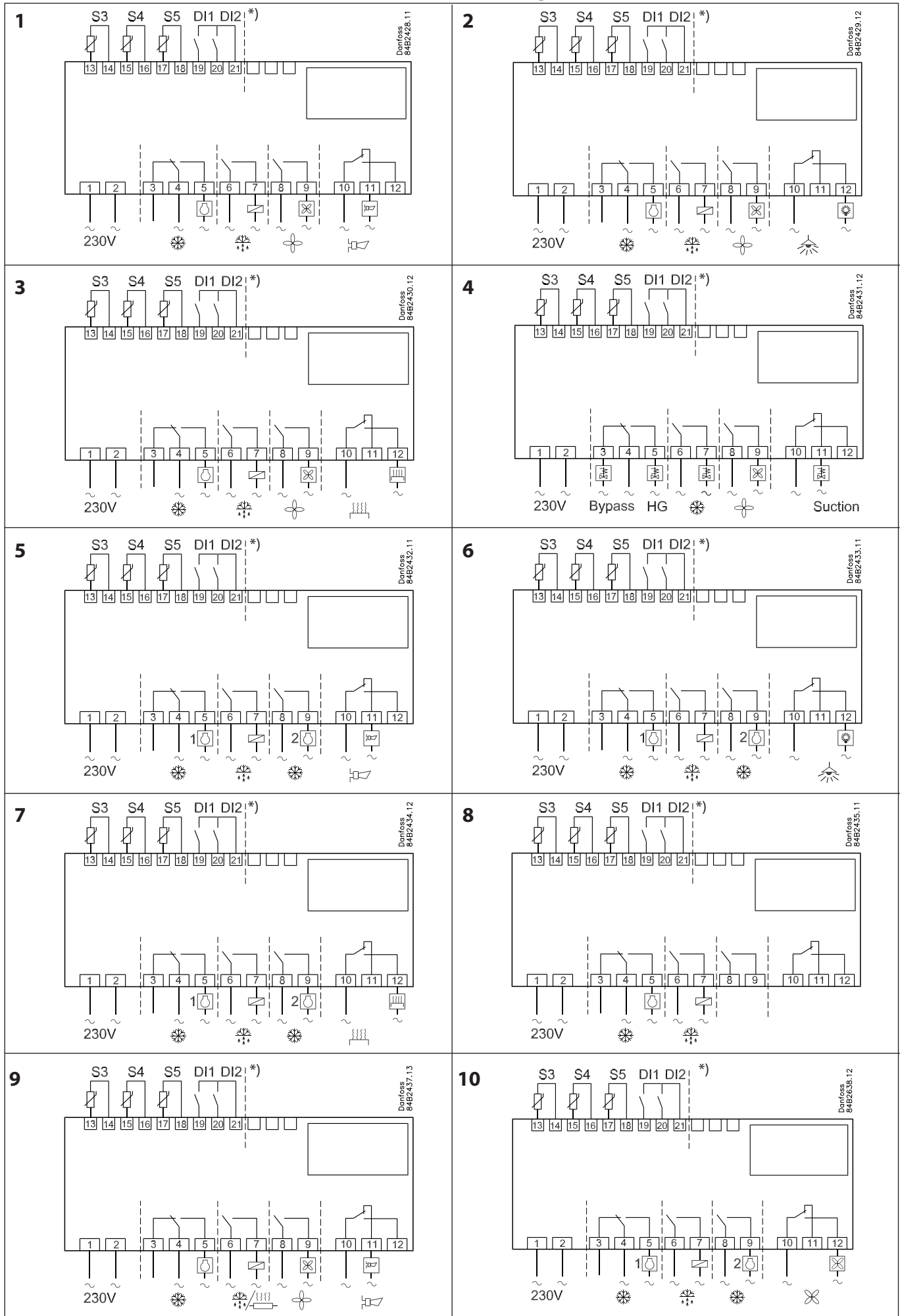

!!! → \*) DI1, DI2: AU: Guld, Gold, Or, Oro ℓ = max. 15 m

**Indstil:**

**1 Åbn parameter r12 og stop reguleringen**

**2 Vælg elforbindelse ud fra tegningerne side 2**

**3 Åbn parameter o61 og indstil elforbindelsesnummeret heri**

**4 Vælg derefter et sæt af forudindstillinger fra tabellen til højre**

**5 Åbn parameter o62 og indstil nummeret for sættet af forudindstillinger**

**6 Åbn parameter r12 og start reguleringen**

**7 Se oversigten over fabriksindstillinger igennem. — Foretag de nødvendige ændringer i de respektive parametre**

**8 Ved netværk. Indstil adressen i o03 og send derefter adressen til gatewayen/systemenheden med indstillingen o04.**

Hjælpekema til indstillinger (quick-setup)	Møbler			Rum		
	Afr. stop på tid	Afr. stop på S5		Afr. stop på tid	Afr. stop på S5	
<b>Sæt af forudindstillinger (o62)</b>	<b>1</b>	<b>2</b>	<b>3</b>	<b>4</b>	<b>5</b>	<b>6</b>
Temperatur (SP)	4°C	2°C	-24°C	6°C	3°C	-22°C
Max. temp. indstilling (r02)	6°C	4°C	-22°C	8°C	5°C	-20°C
Min. temp. indstilling (r03)	2°C	0°C	-26°C	4°C	1°C	-24°C
Følesignal til termostaten. S4% (r15)	100%			0%		
Alarmgrænse høj (A13)	10°C	8°C	-15°C	10°C	8°C	-15°C
Alarmgrænse lav (A14)	-5°C	-5°C	-30°C	0°C	0°C	-30°C
Følesignal til alarmfunk. S4% (A36)	100%			0%		
Interval imellem afrimn. (d03)	6 h	6h	12h	8h	8h	12h
Afrimningsføler: 0=time, 1=S5, 2=S4 (d10)	0	1	1	0	1	1
DI1 config. (o02)	Møbelrengøring (=10)			Dørfunktion (=3)		
Følesignal til displayvisning. S4% (017)	100%			0%		

Sæt 1-6: Indstillingerne i de grå felter bliver ændret

Funktion	Parametre	Koder	EL-diagramnummer (side 2)										Min.-værdi	Max.-værdi	Fabriksindstilling	Aktuel indstilling		
			1	2	3	4	5	6	7	8	9	10						
<b>Normal drift</b>																		
Temperatur (setpunkt)		---													-50.0°C	50.0°C	2.0°C	
<b>Termostat</b>																		
Differens	***	r01													0.1 K	20.0 K	2.0 K	
Max. begrænsning af setpunktsindstilling	***	r02													-49.0°C	50.0°C	50.0°C	
Min. begrænsning af setpunktsindstilling	***	r03													-50.0°C	49.0°C	-50.0°C	
Justering af temperaturvisning		r04													-20.0 K	20.0 K	0.0 K	
Temperaturenhed (°C/°F)		r05													°C	°F	°C	
Korrektion af signalet fra S4		r09													-10.0 K	10.0 K	0.0 K	
Korrektion af signalet fra S3		r10													-10.0 K	10.0 K	0.0 K	
Manuel service, Stop regulering, Start regulering (-1, 0, 1)		r12													-1	1	0	
Referenceforskydning under natdrift		r13													-10.0 K	10.0 K	0.0 K	
Definition og evt. vægtning af termostatfølere - S4% (100%=S4, 0%=S3)		r15													0%	100%	100%	
Varmefunktionen påbegyndes antal grader under termostatens udkoblingstemperatur		r36													-15.0 K	-3.0 K	-15.0 K	
Aktivering af referenceforskydning r40		r39													OFF	ON	OFF	
Værdi for referenceforskydning (aktiveres via r39 eller DI)		r40													-50.0 K	50.0 K	0.0 K	
<b>Alarm</b>																		
Forsinkelse på temperaturalarm		A03													0 min	240 min	30 min	
Forsinkelse på døralarm	***	A04													0 min	240 min	60 min	
Forsinkelse på temperaturalarm efter afrimning		A12													0 min	240 min	90 min	
Høj alarmgrænse	***	A13													-50.0°C	50.0°C	8.0°C	
Lav alarmgrænse	***	A14													-50.0°C	50.0°C	-30.0°C	
Alarm forsinkelse DI1		A27													0 min	240 min	30 min	
Alarm forsinkelse DI2		A28													0 min	240 min	30 min	
Signal til alarmtermostaten. (100%=S4, 0%=S3)		A36													0%	100%	100%	
<b>Kompressor</b>																		
Min. ON-tid		c01													0 min	30 min	0 min	
Min. OFF-tid		c02													0 min	30 min	0 min	
Forsinkelsestid for indkobling af compr. 2		c05													0 sec	999 sec	0 sec	
Kompressorrelæ 1 skal koble modsat (NC-funktion)		c30													0	1	0	
															OFF	ON	OFF	
<b>Afrimning</b>																		
Afrimningsmetode (ingen/EL/GAS/BRINE)		d01													no	bri	EL	
Afrimnings-stoptemperatur		d02													0.0°C	25.0°C	6.0°C	
Interval mellem afrimningsstarter		d03													0 hours	48 hours	8 hours	
Max. afrimningsvarighed		d04													0 min	180 min	45 min	
Tidsforskydning på afrimningsindkoblingen ved opstart		d05													0 min	240 min	0 min	
Afdrypningstid		d06													0 min	60 min	0 min	
Forsinkelse på ventilatorstart efter afrimning		d07													0 min	60 min	0 min	
Ventilator-starttemperatur		d08													-15.0°C	0.0°C	-5.0°C	
Ventilator indkoblet under afrimning		d09													no	yes	yes	
Afrimningsføler (0=tid, 1=S5, 2=S4)		d10													0	2	0	
Pump down forsinkelse		d16													0 min	60 min	0 min	
Drain forsinkelse		d17													0 min	60 min	0 min	
Max. opsummeret køletid imellem to afrimninger		d18													0 hours	48 hours	0 hours	
Behovstyret afrimning - S5 temperaturrens tilladte variation ved isopbygning. På centralanlæg vælges 20 (=off)		d19													0.0 K	20.0 k	20.0 K	
<b>Ventilator</b>																		
Ventilatorstop ved udkoblet kompressor		F01													no	yes	no	
Forsinkelse af ventilatorstop		F02													0 min	30 min	0 min	
Ventilatorstop temperatur (S5)		F04													-50.0°C	50.0°C	50.0°C	

		1	2	3	4	5	6	7	8	9	10				
<b>HACCP</b>															
Aktuel temperaturmåling til HACCP funktionen		h01													
Den sidst registrerede spidstemperatur		h10													
Valg af funktion og føler til HACCP funktionen. 0=ingen HAC-CP funktion. 1=S4 benyttes (evt. også S3). 2=S5 benyttes		h11										0	2	0	
Alarmgrænse for HACCP funktionen		h12										-50.0°C	50.0°C	8.0°C	
Forsinkelsestid for HACCP alarmer		h13										0 min.	240 min.	30 min.	
Vælg signal til HACCP funktionen. S4% (100%=S4, 0%=S3)		h14										0%	100%	100%	
<b>Realtidsur</b>															
Seks starttidspunkter for afrimning. Indstilling af timer. 0=OFF		t01-t06										0 hours	23 hours	0 hours	
Seks starttidspunkter for afrimning. Indstilling af minutter 0=OFF		t11-t16										0 min	59 min	0 min	
Ur - Timeindstilling	***	t07										0 hours	23 hours	0 hours	
Ur - Minutindstilling	***	t08										0 min	59 min	0 min	
Ur - Indstilling af dato	***	t45										1	31	1	
Ur - Indstilling af måned	***	t46										1	12	1	
Ur - Indstilling af år	***	t47										0	99	0	
<b>Diverse</b>															
Forsinkelse af udgangssignaler efter opstart		o01										0 s	600 s	5 s	
Indgangssignal på DI1. Funktion: (0=ikke anvendt, 1=status på DI1. 2=dørfunktion med alarm ved åben. 3=døralarm ved åben. 4=afrimningsstart (pulstryk). 5=ekstern hovedafbryder. 6=natdrift. 7=skift reference (r40 aktiveres), 8=alarmfunktion ved sluttet. 9=alarmfunktion ved åben. 10=møbelrengøring (pulstryk). 11=Tvangskøling ved varmgasafrimning.)		o02										0	11	0	
Netværksadresse		o03										0	240	0	
On/Off omskifter (Service Pin meddelelse) VIGTIG! o61 skal indstilles før o04		o04										OFF	ON	OFF	
Adgangskode 1 (samtlige indstillinger)		o05										0	100	0	
Anvendt følerstype (Pt /PTC/NTC)		o06										Pt	ntc	Pt	
Display step = 0.5 (normal 0.1 ved Pt føler)		o15										no	yes	no	
Max holdetid efter koordineret afrimning		o16										0 min	60 min	20	
Vælg signal til displayvisningen. S4% (100%=S4, 0%=S3)		o17										0%	100%	100%	
Indgangssignal på DI2. Funktion: (0=ikke anvendt, 1=status på DI2. 2=dørfunktion med alarm ved åben. 3=døralarm ved åben. 4=afrimningsstart (pulstryk). 5=ekstern hovedafbryder. 6=natdrift. 7=skift reference (r40 aktiveres), 8=alarmfunktion ved sluttet. 9=alarmfunktion ved åben. 10=møbelrengøring (pulstryk). 11=Tvangskøling ved varmgasafrimning. 12=koordineret afrimning)		o37										0	12	0	
Konfiguration af lysfunktionen (relæ 4) 1=ON under dagdrift. 2=ON / OFF via datakommunikation. 3=ON følger DI-funktionen, når DI er valgt til dørfunktion eller til døralarm		o38										1	3	1	
Aktivering af lysrelæ (kun hvis o38=2)		o39										OFF	ON	OFF	
Kantvarme On-tid under dagdrift		o41										0%	100%	0	
Kantvarme On-tid under natdrift		o42										0%	100%	0	
Kantvarme periodetid (On tid + Off tid)		o43										6 min	60 min	10 min	
Møbelrengøring. 0= ingen møbelrengøring 1= kun ventilatorer. 2 Alle udgange er OFF	***	o46										0	2	0	
Valg af EL-diagram. Se oversigten side 2.	*	o61										1	10	1	
Overfør et sæt af forudindstillinger. Se oversigten på forrige side	*	o62										0	6	0	
Adgangs kode 2 (delvis adgang)	***	o64										0	100	0	
Gem apparatets nuværende indstillinger på programmeringsnøglen. Vælg selv nummer.		o65										0	25	0	
Hent et sæt indstillinger fra programmeringsnøglen (tidligere gemt via o65 funktionen)		o66										0	25	0	
Overskriv regulatorens fabriksindstillinger med de nuværende indstillinger		o67										OFF	On	OFF	
<b>Service</b>															
Statuskoder er vist på side 5		S0-S33													
Temperaturen målt med S5 føleren	***	u09													
Status på DI1 indgangen. 1=sluttet		u10													
Temperaturen målt med S3 føleren	***	u12													
Status på natdrift (on eller off) 1=sluttet	***	u13													
Temperaturen målt med S4 føleren	***	u16													
Termostattertemperaturen		u17													
Aflæs den øjeblikkelige reguleringsreference		u28													
Status på DI2 udgangen. 1=sluttet		u37													
Temperaturen der udlæses på displayet		u56													
Målt temperatur til alarmtermostaten		u57													
Status på relæet til køling	**	u58													
Status på relæet til ventilator	**	u59													
Status på relæet til afrimning	**	u60													
Status på relæet til kantvarme	**	u61													
Status på relæet til alarm	**	u62													
Status på relæet til lys	**	u63													
Status på relæet til ventil i sugeledningen	**	u64													
Status på relæet til kompressor 2	**	u67													

\*) Kan kun indstilles, når reguleringen er stoppet (r12=0)

\*\*) Kan styres manuelt, men kun når r12 = -1

\*\*\*) Med adgangskode 2 begrænses adgangen til disse menuer

SW = 2.0x

Fabriksindstillingen er angivet for standardapparaterne. Er bestillingsnummeret et andet, er fabriksindstillingen ændret iflg. aftale.

## Knapperne

### Indstille en menu

1. Tryk på den øverste knap til der vises en parameter
2. Tryk på øverste eller nederste knap og find hen til den parameter, du vil indstille
3. Tryk på den midterste knap indtil værdien for parameteren vises
4. Tryk på øverste eller nederste knap og find den nye værdi
5. Tryk igen på den midterste knap for at fastlåse værdien.

### Udkoble alarmrelæ / se alarmkode

- Kort tryk på den øverste knap

### Indstille temperaturen

1. Tryk på den midterste knap til temperaturværdien vises
2. Tryk på øverste eller den nederste knap og find den nye værdi
3. Tryk på den midterste knap for at afslutte indstillingen.

### Aflæse temperaturen ved afrimningsføleren

- Kort tryk på den nederste knap

### Manuel start eller stop af en afrimning

- Tryk på den nederste knap i 4 sekunder.

### Se HACCP registrering

1. Langt tryk på den midterste knap til h01 vises
2. Vælg ønsket h01 - h10
3. Se værdien ved kort tryk på den midterste knap.

## LED

### Lysdiode

 = køling

 = afrimning

 = ventilator i gang

Blinker hurtigt ved alarm

## HACCP

Funktionen er aktiv

Visning af fejlkode		Visning af alarmkode		Visning af statuskode	
E 1	Fejl i regulator	A 1	Høj-temperatur alarm	S0	Der reguleres
E 6	Batteriet skal skiftes + kontroller ur	A 2	Lav-temperatur alarm	S1	Venter på at den koordinerede afrimning afsluttes
E 25	S3 føler fejl	A 4	Dør-alarm	S2	ON-tid Kompressor
E 26	S4 føler fejl	A 5	Max. Hold time	S3	OFF-tid kompressor
E 27	S5 føler fejl	A 15	DI 1 alarm	S4	Afdrypningstid
		A 16	DI 2 alarm	S10	Køling stoppet af hovedafbryder
		A 45	Standby mode	S11	Køling stoppet af termostat
		A 59	Møbelrengøring	S14	Afrimningssekvens. Afrimer
		A 60	HACCP alarm	S15	Afrimningssekvens. Ventilatorforsinkelse
				S17	Dør åben (åben DI indgang)
				S20	Nødkøling
				S25	Manuel regulering af udgange
				S29	Møbelrengøring
				S30	Tvangskøling
				S32	Forsinkelse af udgange ved opstart
				S33	Varmefunktionen r36 er aktiv
				non	Afrimningstemperaturen kan ikke vises. Der stoppes på tid
				-d-	Afrimningen er igang
				PS	Password er påkrævet

**Setting:**

- 1 Open parameter r12 and stop the regulation
- 2 Select electric connection based on the drawings on page 2
- 3 Open parameter o61 and set the electric connection number in it
- 4 Now select one of the preset settings from the table on the right-hand side
- 5 Open parameter o62 and set the number for the array of presets
- 6 Open parameter r12 and start the regulation
- 7 Go through the survey of factory settings. Make any necessary changes in the respective parameters.
- 8 For network. Set the address in o03 and then transmit it to the gateway/system unit with setting o04.

Auxiliary table for settings (quick-setup)	Case			Room		
	Defrost stop on time	Defrost stop on S5		Defrost stop on time	Defrost stop on S5	
Preset settings (o62)	1	2	3	4	5	6
Temperature (SP)	4°C	2°C	-24°C	6°C	3°C	-22°C
Max. temp. setting (r02)	6°C	4°C	-22°C	8°C	5°C	-20°C
Min. temp. setting (r03)	2°C	0°C	-26°C	4°C	1°C	-24°C
Sensor signal for thermostat. S4% (r15)	100%			0%		
Alarm limit high (A13)	10°C	8°C	-15°C	10°C	8°C	-15°C
Alarm limit low (A14)	-5°C	-5°C	-30°C	0°C	0°C	-30°C
Sensor signal for alarm funct.S4% (A36)	100%			0%		
Interval between defrost (d03)	6 h	6h	12h	8h	8h	12h
Defrost sensor: 0=time, 1=S5, 2=S4 (d10)	0	1	1	0	1	1
DI1 config. (o02)	Case cleaning =10			Door function =3		
Sensor signal for display view S4% (O17)	100%			0%		

Array 1-6: The settings in the grey fields will be changed

Function	Parameters	Codes	EL-diagram number (page 2)										Min.-value	Max.-value	Factory setting	Actual setting		
			1	2	3	4	5	6	7	8	9	10						
<b>Normal operation</b>																		
Temperature (set point)		---													-50.0°C	50.0°C	2.0°C	
<b>Thermostat</b>																		
Differential	***	r01													0.0 K	20.0K	2.0 K	
Max. limitation of setpoint setting	***	r02													-49.0°C	50°C	50.0°C	
Min. limitation of setpoint setting	***	r03													-50.0°C	49.0°C	-50.0°C	
Adjustment of temperature indication		r04													-20.0 K	20.0 K	0.0 K	
Temperature unit (°C/°F)		r05													°C	°F	°C	
Correction of the signal from S4		r09													-10.0 K	+10.0 K	0.0 K	
Correction of the signal from S3		r10													-10.0 K	+10.0 K	0.0 K	
Manual service, stop regulation, start regulation (-1, 0, 1)		r12													-1	1	0	
Displacement of reference during night operation		r13													-10.0 K	10.0 K	0.0 K	
Definition and weighting, if applicable, of thermostat sensors - S4% (100%=S4, 0%=S3)		r15													0%	100%	100%	
The heating function is started a number of degrees below the thermostats cutout temperature		r36													-15.0 K	-3.0 K	-15.0 K	
Activation of reference displacement r40		r39													OFF	ON	OFF	
Value of reference displacement (activate via r39 or DI)		r40													-50.0 K	50.0 K	0.0 K	
<b>Alarm</b>																		
Delay for temperature alarm		A03													0 min	240 min	30 min	
Delay for door alarm	***	A04													0 min	240 min	60 min	
Delay for temperature alarm after defrost		A12													0 min	240 min	90 min	
High alarm limit	***	A13													-50.0°C	50.0°C	8.0°C	
Low alarm limit	***	A14													-50.0°C	50.0°C	-30.0°C	
Alarm delay DI1		A27													0 min	240 min	30 min	
Alarm delay DI2		A28													0 min	240 min	30 min	
Signal for alarm thermostat. S4% (100%=S4, 0%=S3)		A36													0%	100%	100%	
<b>Compressor</b>																		
Min. ON-time		c01													0 min	30 min	0 min	
Min. OFF-time		c02													0 min	30 min	0 min	
Time delay for cutin of comp.2		c05													0 sec	999 sec	0 sec	
Compressor relay 1 must cutin and out inversely (NC-function)		c30													0	1	0	
															OFF	ON	OFF	
<b>Defrost</b>																		
Defrost method (none/EL/GAS/BRINE)		d01													no	bri	EL	
Defrost stop temperature		d02													0.0°C	25.0°C	6.0°C	
Interval between defrost starts		d03													0 hours	48 hours	8 hours	
Max. defrost duration		d04													0 min	180 min	45 min	
Displacement of time on cutin of defrost at start-up		d05													0 min	240 min	0 min	
Drip off time		d06													0 min	60 min	0 min	
Delay for fan start after defrost		d07													0 min	60 min	0 min	
Fan start temperature		d08													-15.0°C	0.0°C	-5.0°C	
Fan cutin during defrost		d09													no	yes	yes	
Defrost sensor (0=time, 1=S5, 2=S4)		d10													0	2	0	
Pump down delay		d16													0 min	60 min	0 min	
Drain delay		d17													0 min	60 min	0 min	
Max. aggregate refrigeration time between two defrosts		d18													0 hours	48 hours	0 hours	
Defrost on demand - S5 temperature's permitted variation during frost build-up. On central plant choose 20 K (=off)		d19													0.0 K	20.0 k	20.0 K	
<b>Fan</b>																		
Fan stop at cutout compressor		F01													no	yes	no	
Delay of fan stop		F02													0 min	30 min	0 min	
Fan stop temperature (S5)		F04													-50.0°C	50.0°C	50.0°C	

		1	2	3	4	5	6	7	8	9	10				
<b>HACCP</b>															
Actual temperature measurement for the HACCP function		h01													
Last registered peak temperature		h10													
Selection of function and sensor for the HACCP function. 0 = no HACCP function. 1 = S4 used (maybe also S3). 2 = S5 used		h11										0	2	0	
Alarm limit for the HACCP function		h12										-50.0°C	50.0°C	8.0°C	
Time delay for the HACCP alarm		h13										0 min.	240 min.	30 min.	
Select signal for the HACCP function. S4% (100% = S4, 0% = S3)		h14										0%	100%	100%	
<b>Real time clock</b>															
Six start times for defrost. Setting of hours. 0=OFF		t01-t06										0 hours	23 hours	0 hours	
Six start times for defrost. Setting of minutes. 0=OFF		t11-t16										0 min	59 min	0 min	
Clock - Setting of hours	***	t07										0 hours	23 hours	0 hours	
Clock - Setting of minute	***	t08										0 min	59 min	0 min	
Clock - Setting of date	***	t45										1	31	1	
Clock - Setting of month	***	t46										1	12	1	
Clock - Setting of year	***	t47										0	99	0	
<b>Miscellaneous</b>															
Delay of output signals after start-up		o01										0 s	600 s	5 s	
Input signal on DI1. Function: 0=not used. 1=status on DI1. 2=door function with alarm when open. 3=door alarm when open. 4=defrost start (pulse-pressure). 5=ext.main switch. 6=night operation 7=change reference (activate r40). 8=alarm function when closed. 9=alarm function when open. 10=case cleaning (pulse pressure). 11=forced cooling at hot gas defrost.		o02										1	11	0	
Network address		o03										0	240	0	
On/Off switch (Service Pin message) <b>IMPORTANT! o61 must be set prior to o04</b>		o04										OFF	ON	OFF	
Access code 1 (all settings)		o05										0	100	0	
Used sensor type (Pt /PTC/NTC)		o06										Pt	ntc	Pt	
Display step = 0.5 (normal 0.1 at Pt sensor)		o15										no	yes	no	
Max hold time after coordinated defrost		o16										0 min	60 min	20	
Select signal for display view. S4% (100%=S4, 0%=S3)		o17										0%	100%	100%	
Input signal on DI2. Function: (0=not used. 1=status on DI2. 2=door function with alarm when open. 3=door alarm when open. 4=defrost start (pulse-pressure). 5=ext. main switch 6=night operation 7=change reference (activate r40). 8=alarm function when closed. 9=alarm function when open. 10=case cleaning (pulse pressure). 11=forced cooling at hot gas defrost.). 12=coordinated defrost)		o37										0	12	0	
Configuration of light function (relay 4) 1=ON during day operation. 2=ON / OFF via data communication. 3=ON follows the DI-function, when DI is selected to door function or to door alarm		o38										1	3	1	
Activation of light relay (only if o38=2)		o39										OFF	ON	OFF	
Rail heat On time during day operations		o41										0%	100%	0	
Rail heat On time during night operations		o42										0%	100%	0	
Rail heat period time (On time + Off time)		o43										6 min	60 min	10 min	
Case cleaning. 0=no case cleaning. 1=Fans only. 2=All output Off.	***	o46										0	2	0	
Selection of EL diagram. See overview page 2	*	o61*										1	10	1	
Download a set of predetermined settings. See overview previous page.	*	o62*										0	6	0	
Access code 2 (partly access)	***	o64										0	100	0	
Save the controllers present settings to the programming key. Select your own number.		o65										0	25	0	
Load a set of settings from the programming key (previously saved via o65 function)		o66*										0	25	0	
Replace the controllers factory settings with the present settings		o67										OFF	On	OFF	
<b>Service</b>															
Status codes are shown on page 8		S0-S33													
Temperature measured with S5 sensor	***	u09													
Status on DI1 input. on/1=closed		u10													
Temperature measured with S3 sensor	***	u12													
Status on night operation (on or off) 1=closed	***	u13													
Temperature measured with S4 sensor	***	u16													
Thermostat temperature		u17													
Read the present regulation reference		u28													
Status on DI2 output. on/1=closed		u37													
Temperature shown on display		u56													
Measured temperature for alarm thermostat		u57													
Status on relay for cooling	**	u58													
Status on relay for fan	**	u59													
Status on relay for defrost	**	u60													
Status on relay for railheat	**	u61													
Status on relay for alarm	**	u62													
Status on relay for light	**	u63													
Status on relay for valve in suction line	**	u64													
Status on relay for compressor 2	**	u67													

\*) Can only be set when regulation is stopped (r12=0)

\*\*) Can be controlled manually, but only when r12=-1

\*\*\*) With access code 2 the access to these menus will be limited

SW = 2.0x

Factory settings are indicated for standard units. Other code numbers have customized settings.

## The buttons

### Set menu

1. Push the upper button until a parameter r01 is shown
2. Push the upper or the lower button and find that parameter you want to change
3. Push the middle button until the parameter value is shown
4. Push the upper or the lower button and select the new value
5. Push the middle button again to enter the value.

### Cutout alarm relay / receipt alarm/see alarm code

- Push short the upper button

### Set temperature

1. Push the middle button until the temperature value is shown
2. Push the upper or the lower button and select the new value
3. Push the middle button to select the setting.

### Reading the temperature at defrost sensor

- Push briefly the lower button

### Manuel start or stop of a defrost



- Push the lower button for four seconds.

### See HACCP registration

1. Give the middle button a long push until h01 appears
2. Select required h01-h10
3. See value by giving the middle button a short push

## LED

### Light emitting diode

-  = refrigeration
-  = defrost
-  = fan running

Flashes fast at alarm

## HACCP

HACCP function is activ

Fault code display		Alarm code display		Status code display	
E 1	Fault in controller	A 1	High temperature alarm	S0	Regulating
E 6	Change battery + check clock	A 2	Low temperature alarm	S 1	Waiting for end of the coordinated defrost
E 25	S3 sensor error	A 4	Door alarm	S 2	ON-time Compressor
E 26	S4 sensor error	A 5	Max. Hold time	S 3	OFF-time Compressor
E 27	S5 sensor error	A 15	DI 1 alarm	S 4	Drip-off time
		A 16	DI 2 alarm	S 10	Refrigeration stopped by main switch
		A 45	Standby mode	S 11	Refrigeration stopped by thermostat
		A 59	Case cleasning	S 14	Defrost sequence. Defrosting
		A 60	HACCP alarm	S 15	Defrost sequence. Fan delay
				S 17	Door open (open DI input)
				S 20	Emergency cooling
				S 25	Manual control of outputs
				S 29	Case cleaning
				S 30	Forced cooling
				S 32	Delay of output at start-up
				S33	Heat function r36 is active
				non	The defrost temperature cannot be displayed. There is stop based on time
				-d-	Defrost in progress
				PS	Password required



**Einstellen:**

**1 Parameter r12 öffnen und Regelung stoppen**

**2 Elektrische Verbindung von den Zeichnungen auf Seite 2 auswählen**

**3 Parameter o61 öffnen und die Nummer der Elektrischen Verbindung hier einstellen**

**4 Nummer der gewünschten Voreinstellung aus der Tabelle rechts wählen**

**5 Parameter o62 öffnen und die Nummer für den Datensatz von voreinstellungen einstellen**

**6 Parameter r12 öffnen und Regelung starten**

**7 Die Übersicht über Werkseinstellungen durchsehen. — Die notwendigen Änderungen in den jeweiligen Parametern vornehmen.**

**8 Bei Netzwerken: Die Adresse in o03 einstellen und anschließend mit der Einstellung o04 an das Gateway/die Systemeinheit senden.**

Hilftabelle für Einstellungen (quick-setup)	Möbeln			Raum		
	Abtaustop auf zeit	Abtaustop auf S5		Abtaustop auf zeit	Abtaustop auf S5	
<b>Satz von voreinstellungen (o62)</b>	<b>1</b>	<b>2</b>	<b>3</b>	<b>4</b>	<b>5</b>	<b>6</b>
Temperatur (SP)	4°C	2°C	-24°C	6°C	3°C	-22°C
Max. temp. einstellung (r02)	6°C	4°C	-22°C	8°C	5°C	-20°C
Min. temp. einstellung (r03)	2°C	0°C	-26°C	4°C	1°C	-24°C
Fühlersignal für den Thermostaten. S4% (r15)	100%			0%		
Alarmgrenze hoch (A13)	10°C	8°C	-15°C	10°C	8°C	-15°C
Alarmgrenze tief (A14)	-5°C	-5°C	-30°C	0°C	0°C	-30°C
Fühlersignal für Alarmfunk. S4% (A36)	100%			0%		
Intervall zwischen Abtauerungen (d03)	6 h	6h	12h	8h	8h	12h
Abtaufühler : 0=zeit, 1=S5, 2=S4 (d10)	0	1	1	0	1	1
D11 config. (o02)	Möbelreinigung (=10)			Türfunktion (=3)		
Fühlersignal für Displayanzeige. S4% (017)	100%			0%		

Satz 1-6: Einstellungen in den grauen Feldern werden geändert

Funktion	Parameter	Code	EL-Diagramm-nummer (Seite 2)										Min.-Wert	Max.-Wert	Werks-einstellung	Aktuelle Einstellung		
			1	2	3	4	5	6	7	8	9	10						
<b>Normal Betrieb</b>																		
Temperatur (Sollwert)		---														-50.0°C	50.0°C	2.0°C
<b>Thermostat</b>																		
Differenz	***	r01														0.1 K	20.0 K	2.0 K
Max. Begrenzung des Sollwert-einstellung	***	r02														-49.0°C	50.0°C	50.0°C
Min. Begrenzung des Sollwert-einstellung	***	r03														-50.0°C	49.0°C	-50.0°C
Justierung der Temperaturanzeige		r04														-20.0 K	20.0 K	0.0 K
Temperatureinheit (°C/°F)		r05														°C	°F	°C
Korrektur des Signals vom S4		r09														-10.0 K	10.0 K	0.0 K
Korrektur des Signals vom S3		r10														-10.0 K	10.0 K	0.0 K
Manuel Service, Regelung stoppen, Regelung starten (-1, 0, 1)		r12														-1	1	0
Sollwertverschiebung während Nachtbetrieb		r13														-10.0 K	10.0 K	0.0 K
Definition und evtl. gewöhnung der Thermostatfühler - S4%. (100%=S4, 0%=S3)		r15														0%	100%	100%
Die Wärmefunktion wird eine Anzahl von Grad unter dem ausschaltungstemperatur des Thermostaten angefangen		r36														-15.0 K	-3.0 K	-15.0 K
Aktivierung der Sollwertverschiebung r40		r39														OFF	ON	OFF
Wert der Sollwertverschiebung (durch r39 oder DI aktivieren)		r40														-50.0 K	50.0 K	0.0 K
<b>Alarm</b>																		
Verzögerung des Temperaturalarms		A03														0 min	240 min	30 min
Verzögerung des Türalarms	***	A04														0 min	240 min	60 min
Verzögerung auf Temperaturalarm nach Abtauerung		A12														0 min	240 min	90 min
Alarmgrenze hoch	***	A13														-50.0°C	50.0°C	8.0°C
Alarmgrenze tief	***	A14														-50.0°C	50.0°C	-30.0°C
Alarmverzögerung DI1		A27														0 min	240 min	30 min
Alarmverzögerung DI2		A28														0 min	240 min	30 min
Signal für Alarmthermostat. S4% (100%=S4, 0%=S3)		A36														0%	100%	100%
<b>Verdichter</b>																		
Min. ON-Zeit		c01														0 min	30 min	0 min
Min. OFF-Zeit		c02														0 min	30 min	0 min
Verzögerungszeit für eingeschaltete Verdichter 2		c05														0 sec	999 sec	0 sec
Verdichterrelais 1 muss entgegengesetzt schalten (NC-Funktion)		c30														0	1	0
<b>Abtauerung</b>																		
Abtaumethode (keine/EL/GAS/BRINE)		d01														no	bri	EL
Abtau-Stoptemperatur		d02														0.0°C	25.0°C	6.0°C
Intervall zwischen Abtauerungen		d03														0 hours	48 hours	8 hours
Max. Abtaudauer		d04														0 min	180 min	45 min
Zeitverzögerung an der Abtaueinschaltung bei Aufstart		d05														0 min	240 min	0 min
Abtropfzeit		d06														0 min	60 min	0 min
Verzögerung des Lüfterstarts nach der Abtauerung		d07														0 min	60 min	0 min
Lüfter-Starttemperatur		d08														-15.0°C	0.0°C	-5.0°C
Lüfter eingeschaltet während der Abtauerung		d09														no	yes	yes
Abtaufühler (0=Zeit, 1=S5, 2=S4)		d10														0	2	0
Pump down verzögerung		d16														0 min	60 min	0 min
Ablauf Verzögerung		d17														0 min	60 min	0 min
Max. Laufzeit der Kühlung zwischen zwei Abtauerungen		d18														0 hours	48 hours	0 hours
Bedarfsgesteuerte Abtauerung - die S5 Temperatur erlaubt variation bei Eis-aufbauung. Centralanlagen, wähle 20 K (=off)		d19														0.0 K	20.0 k	20.0 K
<b>Lüfter</b>																		
Lüfterstop bei abgeschaltetem Verdichter		F01														no	yes	no
Verzögerung der Lüfterabschaltung		F02														0 min	30 min	0 min
Lüfterstop Temperatur (S5)		F04														-50.0°C	50.0°C	50.0°C

		1	2	3	4	5	6	7	8	9	10				
<b>HACCP</b>															
Aktuelle Temperaturmessung für die HACCP-Funktion	h01														
Die letzte registrierte Spitzentemperatur	h10														
Wahl der Funktion und Fühler für die HACCP-Funktion. 0=keine HACCP-Funktion. 1= S4 wird benutzt (eventuell auch S3). 2=S5 wird benutzt	h11									0	2	0			
Alarmgrenze für HACCP-Funktion	h12									-50.0°C	50.0°C	8.0°C			
Zeitverzögerung für HACCP-Alarm	h13									0 min.	240 min.	30 min.			
Signal für die HACCP-Funktion wählen. S4% (100%=S4, 0%=S3)	h14									0%	100%	100%			
<b>Echtzeituhr</b>															
Sechs Startzeitpunkte für Abtauung. Einstellung in Stunden 0=OFF	t01-t06									0 timer	23 timer	0 timer			
Sechs Startzeitpunkte für Abtauung. Einstellung in Minuten 0=OFF	t11-t16									0 min	59 min	0 min			
Uhr - Einstellung Stunden	*** t07									0 timer	23 timer	0 timer			
Uhr - Einstellung Minuten	*** t08									0 min	59 min	0 min			
Uhr - Einstellung des Datums	*** t45									1	31	1			
Uhr - Einstellung des Monats	*** t46									1	12	1			
Uhr - Einstellung des Jahrs	*** t47									0	99	0			
<b>Diverses</b>															
Verzögerung des Ausgangssignales nach dem Anlauf	o01									0 s	600 s	5 s			
Eingangssignal am DI1. Funktion: (0=wird nicht verwendet. 1=Status am DI1. 2=Türfunktion mit Alarm bei offen. 3=Türalarm bei offen. 4=Abtaustart (Puls-Signal). 5=Ext. Hauptschalter. 6=Nachtbetrieb. 7=Sollwert wechseln (r40 wird aktiviert). 8=Alarmfunktion bei geschlossen. 9=Alarmfunktion bei offen. 10=Möbelreinigung (Puls-Signal). 11=Zwangs-kühlung mit Heissgasabtauung	o02									0	11	0			
Netzwerkadresse	o03									0	240	0			
On/Off Wechselschalter (Service Pin Mitteilung) ACHTUNG! o61 muss vor o04 eingestellt werden	o04									OFF	ON	OFF			
Zugangskode 1 (sämtliche Einstellungen)	o05									0	100	0			
Angewandter Fühlertyp (Pt /PTC/NTC)	o06									Pt	ntc	Pt			
Display step = 0.5 (normal 0.1 bei Pt Fühler)	o15									no	yes	no			
Max Hold time nach koordinierte Abtauung	o16									0 min	60 min	20			
Signal für Displayanzeige wählen. S4% (100%=S4, 0%=S3)	o17									0%	100%	100%			
Eingangssignal am DI2. Funktion: (0=wird nicht verwendet. 1=Status am DI2. 2=Türfunktion mit Alarm bei offen. 3=Türalarm bei offen. 4=Abtaustart (Puls-Signal). 5=Ex-terner Hauptschalter. 6=Nachtbetrieb 7=Sollwert wechseln (r40 wird aktiviert). 8=Alarmfunktion bei geschlossen. 9=Alarmfunktion bei offen. 10=Möbelreinigung (Puls-Signal). 11=Zwangs-kühlung mit Heissgasabtauung. 12=koordinierte Abtauung)	o37									0	12	0			
Konfiguration von Lichtfunktion (Relais 4) 1=ON während Tagesbetrieb. 2=ON / OFF via Datenkommunikation. 3=ON folgt die DI-funktion, wenn DI für Türfunktion oder Türalarm gewählt ist	o38									1	3	1			
Aktivierung von Lichtrelais (Nur wenn o38=2)	o39									OFF	ON	OFF			
Rahmenheizung On-Zeit während Tagesbetrieb	o41									0%	100%	0			
Rahmenheizung On-Zeit während Nachtbetrieb	o42									0%	100%	0			
Rahmenheizung Periodenzeit (On Zeit + Off Zeit)	o43									6 min	60 min	10 min			
Möbelreinigung. 0= Keine Reinigung. 1= Nur Lüfter. 2=Alle Ausgänge OFF.	*** o46									0	2	0			
Wahl des EL-Diagramms. Siehe Übersicht Seite 2.	* o61									1	10	1			
Aktivierung der Voreinstellungen. Siehe Tabelle vorige Seite.	* o62									0	6	0			
Zugangskode 2 (Teilweiser Zugang)	*** o64									0	100	0			
Gegenwärtige Einstellungen des Reglers zu einen Programmierungs Key speichern. Wähle selber eine Nummer.	o65									0	25	0			
Ein Satz von Einstellungen von den Programmierungs Keys laden (früher mit der Funktion o65 gespeichert)	o66									0	25	0			
Die Werkseinstellungen des Reglers mit den jetzigen Einstellungen überschreiben.	o67									OFF	On	OFF			
<b>Service</b>															
Statuskodes sind auf Seite 11 gezeigt	S0-S33														
Temperatur gemessen mit S5 Fühler	*** u09														
Status am DI1 Eingang. 1=geschlossen	u10														
Temperatur gemessen mit S3 Fühler	*** u12														
Status Nachtbetrieb (on oder off) 1=geschlossen	*** u13														
Temperatur gemessen mit S4 Fühler	*** u16														
Thermostattemperatur	u17														
Den augenblicklichen Regelsollwert anzeigen	u28														
Status am DI2 Ausgang. 1=geschlossen	u37														
Temperaturanzeige auf dem Display	u56														
Gemessene Temperatur für den Alarmthermostaten	u57														
Status am Relais für Kühlung	** u58														
Status am Relais für Lüfter	** u59														
Status am Relais für Abtauung	** u60														
Status am Relais für Rahmenheizung	** u61														
Status am Relais für Alarm	** u62														
Status am Relais für Licht	** u63														
Status am Relais für Ventil in der Saugleitung	** u64														
Status am Relais für Verdichter 2	** u67														

\*) Lässt sich nur bei gestoppter Regelung einstellen (r12=0)

\*\*) Lässt sich manuell steuern, jedoch nur bei r12= -1

\*\*\*) Mit Zugangscode 2 wird der Zugang zu diesen Menüs begrenzt

SW = 2.0x

Die Werkseinstellung ist für Standardgeräte angegeben. Ist die Bestell.Nr. eine andere, ist die Werkseinstellung gemäß Absprache geändert

## Tasten

### Menü einstellen

1. Die obere Taste betätigen, bis ein Parameter zur Anzeige gelangt
2. Die obere oder die untere Taste betätigen um zum gewünschten Parameter zu gelangen
3. Die mittlere Taste betätigen, bis der Wert des Parameters zur Anzeige kommt
4. Die obere oder die untere Taste betätigen um einen neuen Wert zu finden
5. Erneut die mittlere Taste betätigen um den Wert festzuhalten.

### Alarmrelais ausschalten/ siehe Alarmcode

- Die oberste Taste kurz betätigen

### Temperatur einstellen

1. Die mittlere Taste betätigen, bis der Temperaturwert zur Anzeige gelangt
2. Die obere oder die untere Taste betätigen um einen neuen Wert zu finden
3. Die mittlere Taste betätigen um den Einstellvorgang abzuschliessen.

### Ablese der Temperatur am Abtaufühler

- Die untere Taste kurz betätigen

### Manueller start oder stop einer Abtaung



- Die untere Taste für etwa 4 Sekunden betätigen.

### Siehe HACCP-Erfassung

1. Lange Betätigung der mittleren Taste, bis h01 angezeigt wird
2. Gewünschten Wert für h01-h10 wählen
3. Den Wert durch kurzes Betätigen der mittleren Taste anzeigen.

## LED

### Leuchtdiode

-  = Kühlung
-  = Abtaung
-  = Lüfter läuft

Blinkt schnell bei Alarm

## HACCP

Funktion ist aktiv

Fehlercodeanzeige		Alarm - Fehlercodeanzeige		Anzeige des Statuscodes	
E 1	Fehler am Regler	A 1	Hoch-temperaturalarm	S0	Es wird geregelt
E 6	Batterie austauschen + Uhr kontrollieren	A 2	Tief-temperaturalarm	S 1	Wartet auf beendigung der koordinierten Abtaung
E 25	S3 Fühler Fehler	A 4	Tür-alarm	S 2	ON-Zeit Verdichter
E 26	S4 Fühler Fehler	A 5	Max. Hold time	S 3	OFF-Zeit Verdichter
E 27	S5 Fühler Fehler	A 15	DI 1 Alarm	S 4	Abtropfzeit
		A 16	DI 2 Alarm	S 10	Kühlung von dem Hauptschalter gestoppt
		A 45	Standby mode	S 11	Kühlung vom Thermostat gestoppt
		A 59	Möbelreinigung	S 14	Abtausequenz. Abtaung
		A 60	HACCP Alarm	S 15	Abtausequenz. Lüfter-Verzögerung
				S 17	Tür offen (DI Eingang offen)
				S 20	Notkühlung
				S 25	Manuelle Regelung der Ausgänge
				S 29	Möbelreinigung
				S 30	Zwangskühlung
				S 32	Verzögerung der Ausgänge bei Anlauf
				S33	Heizfunktion r36 ist aktiv
				non	Abtautemperatur kann nicht angezeigt werden. Es wird zeitabhängig gestoppt.
				-d-	Abtaung ist in Gang
				PS	Passwort ist erforderlich.

# Français

## Réglages:

1 Allez au paramètre r12 et arrêtez le régulateur

2 Choisissez la connexion électrique selon les plans page 2

3 Allez au paramètre o61 pour y inscrire le numéro de la connexion

4 Choisissez ensuite un jeu de pré-réglages de la table à droite

5 Allez au paramètre o62 pour y inscrire le numéro du jeu de pré-réglages

6 Allez au paramètre r12 et mettez la régulation en route

7 Parcourez le sommaire des réglages départ usine. Procédez aux éventuelles modifications nécessaires.

8 En cas de réseau : Inscrivez l'adresse en o03 et envoyez-la ensuite à l'unité passerelle/système avec le réglage o04.

Schéma d'aide pour les réglages (procédé rapide)	Meubles			Chambre froide		
	Top dégivr. sur temps	Top dégivr. selon S5		Top dégivr. sur temps	Top dégivr. selon S5	
Jeu de pré-réglages (o62)	1	2	3	4	5	6
Température (SP)	4°C	2°C	-24°C	6°C	3°C	-22°C
Température maxi (r02)	6°C	4°C	-22°C	8°C	5°C	-20°C
Température mini (r03)	2°C	0°C	-26°C	4°C	1°C	-24°C
Signal de capteur vers le thermostat. S4% (r15)	100%			0%		
Limites d'alarme haute (A13)	10°C	8°C	-15°C	10°C	8°C	-15°C
Limites d'alarme basse (A14)	-5°C	-5°C	-30°C	0°C	0°C	-30°C
Signal de capteur vers la fonction d'alarme. S4% (A36)	100%			0%		
Intervalle entre démarrages du dégivrage (d03)	6 h	6h	12h	8h	8h	12h
Sonde de dégivrage: 0=temps,1=S5, 2=S4 (d10)	0	1	1	0	1	1
DI1 config. (o02)	Nettoyage de meuble (=10)			Fonction porte (=3)		
Signal de capteur vers l'afficheur. S4% (r17)	100%			0%		

Jeux 1 à 6 : les cases grises changent de réglage

Fonction	Paramètres		Numéro schéma électrique										Valeur mini	Valeur maxi	Réglage usine	Réglage actuel				
		Codes	1	2	3	4	5	6	7	8	9	10								
<b>Fonctionnement normal</b>																				
Température (point de consigne)		---															-50.0°C	50.0°C	2.0°C	
<b>Thermostat</b>																				
Différentiel	***	r01															0.0 K	20.0 K	2.0 K	
Limite max. de température de réglage	***	r02															-49.0°C	50.0°C	50.0°C	
Limite min. de température de réglage	***	r03															-50.0°C	49.0°C	-50.0°C	
Réglage de l'affichage de température		r04															-20.0 K	20.0 K	0.0 K	
Unités de température (°C/°F)		r05															°C	°F	°C	
Correction du signal en provenance de S4		r09															-10.0 K	10.0 K	0.0 K	
Correction du signal en provenance de S3		r10															-10.0 K	10.0 K	0.0 K	
Service manuel, Arrêt régulation, marche régulation (-1, 0, 1)		r12															-1	1	0	
Décalage de référence en régime de nuit		r13															-10.0 K	10.0 K	0.0 K	
Définition et pondération éventuelle des sondes thermostatiques. - S4% (100%=S4, 0%=S3)		r15															0%	100%	100%	
Niveau sous la température enclenchement du thermostat où la fonction chaleur doit s'activer		r36															-15.0 K	-3.0 K	-15.0 K	
Actionnement d'une déviation de référence r40		r39															OFF	ON	OFF	
Valeur de la déviation de référence (activation par r39 ou DI)		r40															-50.0 K	50.0 K	0.0 K	
<b>Alarme</b>																				
Temporisation de l'alarme température		A03															0 min	240 min	30 min	
Temporisation de l'alarme porte	***	A04															0 min	240 min	60 min	
Temporisation de l'alarme température après le dégivrage		A12															0 min	240 min	90 min	
Limites d'alarme haute	***	A13															-50.0°C	50.0°C	8.0°C	
Limites d'alarme basse	***	A14															-50.0°C	50.0°C	-30.0°C	
Temporisation de l'alarme DI1		A27															0 min	240 min	30 min	
Temporisation de l'alarme DI2		A28															0 min	240 min	30 min	
Signal vers le thermostat d'alarme. S4% (100%=S4, 0%=S3)		A36															0%	100%	100%	
<b>Compresseur</b>																				
Temps de marche min.		c01															0 min	30 min	0 min	
Intervalle entre deux démarrages		c02															0 min	30 min	0 min	
Temporisation de l'enclenchement du compresseur 2		c05															0 sec	999 sec	0 sec	
Le relais de compresseur 1 doit agir inversement. (fonction NF)		c30															0	1	0	
																	OFF	ON	OFF	
<b>Dégivrage</b>																				
Méthode (non/EL/GAS/BRINE)		d01															no	bri	EL	
Température d'arrêt du dégivrage		d02															0.0°C	25.0°C	6.0°C	
Intervalle entre démarrages du dégivrage		d03															0 hours	48 hours	8 hours	
durée max. du dégivrage		d04															0 min	180 min	45 min	
Retard du dégivrage à la mise sous-tension		d05															0 min	240 min	0 min	
Temps d'égouttement		d06															0 min	60 min	0 min	
Temporisation de démarrage du ventilateur après le dégivrage		d07															0 min	60 min	0 min	
Température de démarrage du ventilateur		d08															-15.0°C	0.0°C	-5.0°C	
Ventilateur enclenché pendant le dégivrage		d09															no	yes	yes	
Test de la sonde de dégivrage (0=temps, 1=S5, 2=S4)		d10															0	2	0	
Temporisation de la mise au vide		d16															0 min	60 min	0 min	
Temporisation de drainage		d17															0 min	60 min	0 min	
Temps de refroidissement total maxi entre deux dégivrages		d18															0 hours	48 hours	0 hours	
Dégivrage sur demande - variation admissible de la température S5 en cas de formation de givre Pour les installations centralisées, on choisit 20 K (= OFF)		d19															0.0 K	20.0 k	20.0 K	
<b>Ventilateur</b>																				
Arrêt du ventilateur à compresseur déclenché		F01															no	yes	no	
Temporisation de l'arrêt du ventilateur		F02															0 min	30 min	0 min	
Arrêt de ventilateur température (S5)		F04															-50.0°C	50.0°C	50.0°C	

		1	2	3	4	5	6	7	8	9	10				
<b>HACCP</b>															
Mesure de température actuelle pour la fonction HACCP.		h01													
La dernière température de pointe enregistrée		h10													
Choix de fonction et de sonde pour la fonction HACCP. 0 = sans fonction HACCP. 1 = Sonde S4 (éventuellement S3 aussi) 2 = Sonde S5		h11									0	2	0		
Limite d'alarme pour la fonction HACCP		h12									-50.0°C	50.0°C	8.0°C		
Temporisation de l'alarme HACCP		h13									0 min.	240 min.	30 min.		
Choix de signal pour la fonction HACCP. S4% (100%=S4, 0%=S3)		h14									0%	100%	100%		
<b>Horloge en temps réel</b>															
Heures de démarrage des six dégivrages		t01-													
Réglage heures. 0=OFF		t06									0 hours	23 hours	0 hours		
Heures de démarrage des six dégivrages		t11-													
Réglage heures. 0=OFF		t16									0 min	59 min	0 min		
Horloge - Réglage heures	***	t07									0 hours	23 hours	0 hours		
Horloge - Réglage minutes	***	t08									0 min	59 min	0 min		
Horloge - Horloge - Réglage date	***	t45									1	31	1		
Horloge - Horloge - Réglage mois	***	t46									1	12	1		
Horloge - Horloge - Réglage année	***	t47									0	99	0		
<b>Divers</b>															
Temporisation des signaux de sortie lors de la mise en route		o01									0 s	600 s	5 s		
Signaux d'entrée DI1. Fonction: (0= non utilisée, 1=état de DI1. 2=fonction porte avec alarme d'ouverture 3=alarme porte ouverte. 4=début de dégivrage (poussoir). 5=interrupteur principal externe. 6=régime de nuit. 7=changer de référence (activation r40). 8=fonction d'alarme à enclenchement. 9=fonction d'alarme à déclenchement. 10=nettoyage de meuble (poussoir). 11=Refroidissement forcé lors du dégivrage par gaz chaud.)		o02									0	11	0		
Adresse réseau		o03									0	240	0		
Commutateur On/Off (message broche service) <b>IMPORTANT ! Il faut régler o61 avant o04</b>		o04									OFF	ON	OFF		
Code d'accès 1 (tous les réglages)		o05									0	100	0		
Type de sonde utilisé (Pt /PTC/NTC)		o06									Pt	ntc	Pt		
Cran d'affichage = 0.5 (norme 0,1/capteur Pt)		o15									no	yes	no		
Temps d'attente max. après dégivrage coordonné		o16									0 min	60 min	20		
Choix de signal pour l'afficheur. S4% (100%=S4, 0%=S3)		o17									0%	100%	100%		
Signaux d'entrée DI2. Fonction: (0= non utilisée, 1=état de DI2. 2=fonction porte avec alarme d'ouverture. 3=alarme porte ouverte. 4=début de dégivrage (poussoir). 5=interrupteur principal externe. 6=régime de nuit. 7=changer de référence (activation r40). 8=fonction d'alarme à enclenchement. 9=fonction d'alarme à déclenchement. 10=nettoyage de meuble (poussoir). 11=Refroidissement forcé lors du dégivrage par gaz chaud. 12=dégivrage coordonné)		o37									0	12	0		
Configuration de la fonction d'éclairage (relais 4) 1=ON en régime de jour. 2=ON/OFF par la transmission de données. 3=ON suivant la fonction DI, si DI a été choisie pour la fonction ou l'alarme porte		o38									1	3	1		
Actionnement du relais d'éclairage (seulement si o38=2)		o39									OFF	ON	OFF		
Rails antibuée, temps ON en régime de jour		o41									0%	100%	0		
Rails antibuée, temps ON en régime de nuit		o42									0%	100%	0		
Rails antibuée, période (temps ON + temps OFF)		o43									6 min	60 min	10 min		
Nettoyage de meuble. 0=aucun nettoyage 1=ventilateurs seulement. 2=toutes les sorties sont OFF	***	o46									0	2	0		
Choix de schéma électrique. Reportez-vous à la table récapitulative page 2.	*	o61*									1	10	1		
Transfert d'un jeu de pré-réglages. Voir le tableau récapitulatif à la page précédente.	*	o62*									0	6	0		
Code d'accès 2 (accès partiel)	***	o64									0	100	0		
Conservez les réglages actuels de l'appareil comme clé de programmation. Choisissez votre propre numéro.		o65									0	25	0		
Appel d'un jeu de réglages de la clé de programmation. (sauvée auparavant via la fonction o65)		o66*									0	25	0		
Surchargez les réglages usine avec les réglages actuels du régulateur		o67									OFF	On	OFF		
<b>Entretien</b>															
Les codes d'état ressortent page 14		S0-S33													
Température relevée par la sonde S5	***	u09													
Etat de l'entrée DI1. On/1=enclenchée		u10													
Température relevée par la sonde S3	***	u12													
Etat du régime de nuit (tout ou rien) 1=enclenché	***	u13													
Température relevée par la sonde S4	***	u16													
Température du thermostat		u17													
Affichage de la référence de régulation actuelle		u28													
Etat de la sortie DI2. On/1=enclenchée		u37													
Température visualisée par l'afficheur		u56													
Température captée pour le thermostat d'alarme		u57													
Etat du relais de refroidissement	**	u58													
Etat du relais du ventilateur	**	u59													
Etat du relais de dégivrage	**	u60													
Etat du relais des rails antibuée	**	u61													
Etat du relais d'alarme	**	u62													
Etat du relais d'éclairage	**	u63													
Etat du relais de la vanne de la conduite d'aspiration	**	u64													
Etat du relais du compresseur 2	**	u67													

\*) Ce réglage n'est possible que si la régulation est arrêtée (r12=0)

\*\*) La commande manuelle est possible mais à condition que r12=-1

\*\*\*) Le code d'accès 2 permet de limiter les accès à ces menus

SW = 2.0x  
Le réglage départ usine spécifié s'applique aux appareils standards. Un autre numéro de code indique un réglage départ usine modifié en accord avec le client.

## Les Boutons

### Réglage d'un menu

1. Appuyez sur le bouton supérieur jusqu'à apparition d'un paramètre.
2. Appuyez sur le bouton supérieur ou inférieur pour trouver le paramètre à régler
3. Appuyez sur le bouton médian jusqu'à apparition de la valeur du paramètre
4. Appuyez sur le bouton supérieur ou inférieur pour chercher la nouvelle valeur
5. Appuyez à nouveau sur le bouton médian pour verrouiller la valeur.

### Déclenchement du relais d'alarme ou visualisation du code d'alarme

- Appuyez brièvement sur le bouton supérieur

### Réglage de la température

1. Appuyez sur le bouton médian jusqu'à apparition de la valeur de température
2. Appuyez sur le bouton supérieur ou inférieur pour chercher la nouvelle valeur
3. Appuyez sur le bouton médian pour terminer le réglage.

### Contrôle de la température de sonde du dégivrage

- Appuyez brièvement sur le bouton inférieur

### Marche/arrêt manuel d'un dégivrage



- Appuyez sur le bouton inférieur pendant 4 secondes.

### Voyez l'enregistrement HACCP

1. Pression prolongée sur le bouton du milieu jusqu'à apparition de h01
2. Choisissez de h01 à h10
3. Pression brève sur le bouton du milieu pour voir la valeur.

## Diodes lumineuses en façade

### Diode lumineuse

-  = refroidissement
-  = dégivrage
-  = Ventilateur en marche

Clignotement rapide en cas d'alarme

### HACCP

La fonction HACCP est active

Affichage de codes de défauts		Affichage code alarme		Affichage des états	
E 1	Défaut de régulateur	A 1	Alarme température haute	S 0	Régulation en cours
E 6	Changer la pile + vérifier heure	A 2	Alarme température basse	S 1	Attend la fin du dégivrage coordonné
E 25	Erreur de sonde S3	A 4	Alarme porte	S 2	Temps ON du compresseur
E 26	Erreur de sonde S4	A 5	Max. Hold time	S 3	Temps OFF du compresseur
E 27	Erreur de sonde S5	A 15	DI 1 alarme	S 4	Egouttage
		A 16	DI 2 alarme	S 10	Le refroidissement a été arrêté au "Main switch" (interrupteur principal)
		A 45	Standby mode	S 11	Le refroidissement a été arrêté au le thermostat
		A 59	Nettoyage de meuble	S 14	Séquence de dégivrage. Dégivrage en cours
		A 60	HACCP alarme	S 15	Séquence de dégivrage. Temporisation du ou des ventilateurs
				S 17	Porte ouverte (Entrée DI ouverte)
				S 20	Refroidissement de secours
				S 25	Régulation manuelle les sorties
				S 29	Nettoyage de meuble
				S 30	Refroidissement forcé
				S 32	Temporisation des sorties à la mise en route
				S33	Fonction chauffe r36 active
				non	Température de dégivrage pas accessible
				-d-	Arrêt sur temps
				-d-	Dégivrage en cours
				PS	Mot de passe imposé

**Puesta en marcha rápida:**

- 1 Entrar en el parámetro r12 para parar el equipo: r12 = 0.
- 2 Elegir la aplicación deseada a partir de los modelos de la página 2
- 3 Programar la aplicación elegida en o61.
- 4 Elegir una de las pre-programaciones básicas a partir de las opciones.
- 5 Programar la pre-programación deseada en o62.
- 6 Entrar nuevamente en el parámetro r12 para arrancar el equipo: r12 = 1.
- 7 Repasar los ajustes de fábrica por si hubiese que retocar alguno.
- 8 Si el equipo está conectado a un bus de comunicaciones, programar la dirección asignada en o03 y transmitirla a la gateway con o04.

Tabla de ajustes preprogramados (Puesta en marcha rápida)	Mueble			Cámara		
	Desescarche por tiempo	Desescarche por S5		Desescarche por tiempo	Desescarche por S5	
Preprogramación básica (o62)	1	2	3	4	5	6
Temperatura (SP)	4°C	2°C	-24°C	6°C	3°C	-22°C
Lím. máx. al ajustar temp. de corte (r02)	6°C	4°C	-22°C	8°C	5°C	-20°C
Lím. mín. al ajustar temp. de corte (r03)	2°C	0°C	-26°C	4°C	1°C	-24°C
Definición de la sonda del termostato % de S4(r15)	100%			0%		
Límite de alarma por alta temp. (A13)	10°C	8°C	-15°C	10°C	8°C	-15°C
Límite de alarma por baja temp. (A14)	-5°C	-5°C	-30°C	0°C	0°C	-30°C
Definición de la sonda de alarma % de S4 (A36)	100%			0%		
Intervalo entre desescarches (d03)	6 h	6h	12h	8h	8h	12h
Sonda de fin de desescarche 0=no, 1=S5, 2=S4 (d10)	0	1	1	0	1	1
Función entrada digital DI1 (o02)	Limpieza del mueble =10			Función de puerta =3		
Definición de la sonda en el display % de S4 (017)	100%			0%		

Conjunto 1-6: Los ajustes de las casillas en gris, serán modificados.

Función	Parámetros	Código	Número de esquema eléctrico										Valor mínimo	Valor máximo	Ajuste fábrica	Ajuste actual			
			1	2	3	4	5	6	7	8	9	10							
<b>Funcionamiento normal</b>																			
Temperatura de corte (set point)		---															-50.0°C	50.0°C	2.0°C
<b>Termostato</b>																			
Diferencial del termostato		r01															0.1 K	20.0 K	2.0 K
Límite máximo al ajustar la temperatura de corte		r02															-49.0°C	50.0°C	50.0°C
Límite mínimo al ajustar la temperatura de corte		r03															-50.0°C	49.0°C	-50.0°C
Corrección de la temperatura del display		r04															-20.0 K	20.0 K	0.0 K
Unidades de temperatura (°C/°F)		r05															°C	°F	°C
Calibración de la sonda S4		r09															-10.0 K	+10.0 K	0.0 K
Calibración de la sonda S3		r10															-10.0 K	+10.0 K	0.0 K
Marcha /paro interno: -1=modo manual, 0=OFF, 1=en marcha		r12															-1	1	0
Desplazamiento de la temp. de corte durante la noche		r13															-10.0 K	10.0 K	0.0 K
Definición de la sonda del termostato, % de S4 (100%=S4, 0%=S3)		r15															0%	100%	100%
Decremento respecto a Tª de corte para empezar a calentar		r36															-15.0 K	-3.0 K	-15.0 K
Activar el incremento de la temperatura de corte r40		r39															OFF	ON	OFF
Incremento de la temperatura de corte (grados) (activación por r39 o DI)		r40															-50.0 K	50.0 K	0.0 K
<b>Alarma</b>																			
Retardo de alarma de temperatura (estándar)		A03															0 min	240 min	30 min
Retardo de alarma de puerta		A04															0 min	240 min	60 min
Retardo de alarma de temp. (después del desescarche y al arrancar)		A12															0 min	240 min	90 min
Límite de alarma por alta temperatura		A13															-50.0°C	50.0°C	8.0°C
Límite de alarma por baja temperatura		A14															-50.0°C	50.0°C	-30.0°C
Retardo de alarma asociada a DI1		A27															0 min	240 min	30 min
Retardo de alarma asociada a DI2		A28															0 min	240 min	30 min
Definición sonda de alarma % de S4 (100%=S4, 0%=S3)		A36															0%	100%	100%
<b>Compresor</b>																			
Mínimo tiempo de compresor en marcha (minutos)		c01															0 min	30 min	0 min
Mínimo tiempo entre dos arranques consecutivos (minutos)		c02															0 min	30 min	0 min
Retraso en arrancar el 2º compresor		c05															0 sec	999 sec	0 sec
Invertir el funcionamiento de la salida DO1 (compresor)		c30															0	1	0
																	OFF	ON	OFF
<b>Desescarche</b>																			
Tipo de desescarche (none/EL/GAS/BRINE=salmuera)		d01															no	bri	EL
Temperatura de fin de desescarche		d02															0.0°C	25.0°C	6.0°C
Intervalo de tiempo entre desescarches		d03															0 hours	48 hours	8 hours
Duración máxima del desescarche		d04															0 min	180 min	45 min
Desplaz. del 1º desescarche tras dar tensión al equipo		d05															0 min	240 min	0 min
Tiempo de goteo		d06															0 min	60 min	0 min
Retardo del ventilador tras el desescarche		d07															0 min	60 min	0 min
Temperatura arranque ventilador		d08															-15.0°C	0.0°C	-5.0°C
Ventilador en marcha durante desescarche (no/yes)		d09															no	yes	yes
Sonda de fin de desescarche (0=no, 1=S5, 2=S4)		d10															0	2	0
Tiempo de vaciado del evaporador (antes del inicio desescarche)		d16															0 min	60 min	0 min
Tiempo de drenaje con válvula by-pass (sólo gas caliente)		d17															0 min	60 min	0 min
Desescarche bajo demanda: tiempo acumulado refrigerando		d18															0 hours	48 hours	0 hours
Desescarche bajo demanda: variación permitida a S5		d19															0.0 K	20.0 k	20.0 K
<b>Ventiladores</b>																			
Parar ventilador al parar compresor		F01															no	yes	no
Retardo de parada del ventilador		F02															0 min	30 min	0 min
Temperatura de paro del ventilador (medida con S5)		F04															-50.0°C	50.0°C	50.0°C

		1	2	3	4	5	6	7	8	9	10				
<b>HACCP</b>															
Medida de temp. actual para la función HACCP	h01														
Última temperatura pico registrada	h10														
Selección de función y sonda para la función HACCP. 0=sin función HACCP, 1= 4 y/o S3 (ver h14) 2=S5 usado.	h11									0	2	0			
Límite de alarma para la función HACCP.	h12									-50.0°C	50.0°C	8.0°C			
Retraso de tiempo para la alarma HACCP	h13									0 min.	240 min.	30 min.			
Seleccionar sonda para la función HACCP. S4 y/o S3 (100% = S4, 0% = S3)	h14									0	100%	100%			
<b>Reloj de tiempo real</b>															
Hasta seis horas (hh) de inicio de desescarche (0=OFF)	t01-t06									0 hours	23 hours	0 hours			
Los minutos (mm) de cada una de las 6 horas (0=OFF)	t11-t16									0 min	59 min	0 min			
Ajuste de reloj: hora	t07									0 hours	23 hours	0 hours			
Ajuste de reloj: minutos	t08									0 min	59 min	0 min			
Ajuste de reloj: día	t45									1	31	1			
Ajuste de reloj: mes	t46									1	12	1			
Ajuste de reloj: año	t47									0	99	0			
<b>Varios</b>															
Retardo de activación de salidas al dar tensión al equipo	o01									0 s	600 s	5 s			
Función de la entrada digital DI1: 0=no utilizada, 1=comunica el estado de la DI, 2=puerta abierta y alarma, 3=sólo la alarma de puerta 4=pulso para iniciar un desescarche 5=interruptor principal 6=operación nocturna 7=desplazamiento temperatura de corte (ac- tivación r40). 8=alarma al cerrar el contacto 9=alarma al abrir el contacto 10=limpieza del mueble (pulso) 11=forzar frío (gas caliente)	o02									1	11	0			
Dirección del AK	o03									0	200	0			
Enviar la dirección del AK a la gateway <b>IMPORTANTE: se debe ajustar o61 antes que o04</b>	o04									OFF	ON	OFF			
Código de acceso nivel 1 (0=código desactivado)	o05									0	100	0			
Tipo de sonda utilizada (Pt /PTC/NTC)	o06									Pt	ntc	Pt			
Precisión del valor de display: YES=0.5, no =0.1	o15									no	yes	no			
Máx. tiempo de espera tras un desescarche coordinado	o16									0 min	60 min	20			
Definición de la sonda en display, %S4 (100%=S4, 0%=S3)	o17									0%	100%	100%			
Función de la entrada digital DI2: 0=no utilizada. 1=comunica el estado de la DI. 2=puerta abierta y alarma 3=sólo la alarma de puerta. 4=pulso para iniciar un desescarche. 5=interruptor principal 6=oper- ación nocturna 7=desplazamiento temperatura de corte (activación r40). 8=alarma al cerrar el contacto. 9=alarma al abrir el contacto. 10=limpieza del mueble (pulso). 11=forzar frío (gas caliente). 12=desescarche coordinado.	o37									0	12	0			
Función de luz (relé 4 en aplicaciones 2 y 6) 1=ON durante operación día. 2=ON / OFF vía bus de comunicaciones. 3=ON a la vez que la DI cuando esa DI es para la función de puerta ó alarma de puerta.	o38									1	3	1			
Activación del relé de luz vía bus de comunicaciones (sólo si o38=2)	o39									OFF	ON	OFF			
Funcionamiento de antivaho durante el día (% sobre o43)	o41									0%	100%	0			
Funcionamiento de antivaho durante la noche (% sobre o43)	o42									0%	100%	0			
Periodo total de funcionamiento de antivaho (ciclo)	o43									6 min	60 min	10 min			
Limpieza del mueble: 0 = no activo, 1 = sólo el venti- lador en ON, 2 = todas las salidas en OFF	o46									0	2	0			
Tipo de aplicación (ver opciones en el manual, página 2)	o61*									1	10	1			
Tipo de pre-programación básica (ver opciones en el manual, página 15)	o62*									0	6	0			
Código de acceso nivel 2 (0=desactivar código)	o64									0	100	0			
Salvar la programación de un AK en una "copy-key"	o65									0	25	0			
Volcar la programación desde una "copy-key" a un AK	o66									0	25	0			
Sustituir los "ajustes de fábrica" por la programación actual	o67									OFF	On	OFF			
<b>Parámetros informativos (servicio)</b>															
Los códigos de estado se muestran en la página 17	S0-S33														
Temperatura medida con la sonda S5	u09														
Estado de la entrada DI1 (OFF=contacto abierto/ ON=contacto cerrado)	u10														
Temperatura medida con la sonda S3	u12														
Operación nocturna (OFF=no activa/ON=activa)	u13														
Temperatura medida con la sonda S4	u16														
Temperatura medida con la "sonda de corte" (S4%)	u17														
Temperatura de corte (set point)	u28														
Estado de la entrada DI2 (OFF=contacto abierto/ ON=contacto cerrado)	u37														
Temperatura medida con la "sonda de display" (S4%)	u56														
Temperatura medida con la "sonda de alarma" (S4%)	u57														
** Estado del relé de frío	u58														
** Estado del relé de ventilador	u59														
** Estado del relé de desescarche	u60														
** Estado del relé de antivaho	u61														
** Estado del relé de alarma	u62														
** Estado del relé de luz	u63														
** Estado del relé de válvula de aspiración	u64														
** Estado del relé para compresor 2	u67														

\*) Sólo pueden ajustarse si el AK-CC está parado (r12=0)

\*\*) Pueden operarse manualmente si r12=-1

\*\*\*) Con código de acceso 2, el acceso a estos menús será limitado.

SW = 2.0x



## Los botones

### Ajustar parámetros

1. Pulsar el botón superior hasta que aparece el parámetro r01.
2. Pulsar los botones alto y bajo hasta encontrar el parámetro deseado.
3. Pulsar el botón central para ver el valor actual.
4. Pulsar los botones alto y bajo para modificar el valor.
5. Pulsar el botón central para confirmar el nuevo valor..

### Rearmar el relé de alarma/ver el código de alarma

- Pulsar y soltar el botón alto  
Si hay varios códigos de alarmas activos, se verán cíclicamente pulsando sucesivamente el botón alto ó bajo.

### Ajustar la temperatura de corte

1. Pulsar el botón central para ver el valor actual.
2. Pulsar los botones alto y bajo para modificar el valor.
3. Pulsar el botón central para confirmar el nuevo valor.

### Leer la temperatura de la sonda de desescarche

- Pulsar y soltar el botón bajo

### Iniciar/para un desescarche manualmente

- Pulsar y mantener el botón bajo 4s.

### Ver registro HACCP

1. Pulsar el botón central continuamente hasta que aparezca h01.
2. Pulsar los botones alto y bajo para seleccionar el parámetro deseado h01-h10.
3. Pulsar el botón central para leer el valor del parámetro

## LED's en el Display

LED's lunimosos

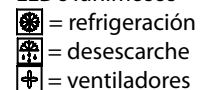

Parpadean cuando hay alarma

## HACCP

La función HACCP está activada

Códigos para informar de fallos		Códigos para informar de alarmas		Códigos de estado	
E 1	Fallo del controlador	A 1	Alarma por alta temperatura	S0	Enfriando
E 6	Fallo del reloj (comprobar pila y "resetear" reloj)	A 2	Alarma por baja temperatura	S 1	esperando el final del desescarche coordinado
E 25	Error sonda S3	A 4	Alarma de puerta	S 2	Compresor dentro del mín. tiempo en marcha.
E 26	Error sonda S4	A 5	El tiempo de espera tras desescarche coordinado (o16) ha expirado	S 3	Compresor mín. tiempo entre arranques consecutivos.
E 27	Error sonda S5	A 15	Alarma asociada a DI 1	S 4	Tiempo de goteo en curso.
		A 16	Alarma asociada a DI 2	S 10	Equipo parado (desde r12 ó desde DI)
		A 45	AK parado (ya sea por "r12" ó por una DI)	S 11	Refrigeración parada. (Se ha alcanzado la temperatura de corte).
		A 59	Limpieza de mueble	S 14	Desescarchando
		A 60	Alarma por alta temperatura para la función HACCP	S 15	Retraso del ventilador tras desescarche.
				S 17	Puerta abierta
				S 20	Refrigeración en emergencia.
				S 25	Control manual, forzado, activo.
				S 29	Limpieza del mueble
				S 30	Frío forzado
				S 32	Retraso inicial al dar tensión al equipo
				S33	Calentando (r36 activo)
				non	No se puede mostrar la temperatura de desescarche. No hay sonda
				-d-	Se está realizando un desescarche
				PS	PS: introduzca contraseña (Código de acceso)





