

Technical brochure

Minicontactors

CI 5-



Contents

Page

Minicontactor CI 5-	
Introduction	4
Ordering	4
Auxiliary contact blocks CI 5-	5
Accessories for minicotators CI 5-	5
Thermal overload relay TI 9C-5	
Introduction	6
Ordering	6
Construction standards	7
Rated life	7
Approvals and standards	7
Electrical life curves	8
Tripping graph	9
Contact symbols and control relays terminal markings	10
Main circuit	11
Power loss	13
Short circuit coordination	13
Control circuit	14
UL specifications	15
Dimensions	16

Introduction



CI 5- minicontactors cover the power range up to 5.5 kW and are available for AC and DC coil voltages enabling reliable working with extremely low and high voltage fluctuations. Characteristic of the minicontactors is that they are compact and suitable for applications where space is at a premium. With add-on auxiliary contact blocks, timers and other additional accessories they offer high flexibility. One of the most important features is status feedback provided by mechanically linked and mirror contact performance in conformity with IEC 60947-4-1 and 60947-5-1. Additionally the CI 5- ensures safety against electric shock by extra protective distance between housing surfaces and live parts. The CI 5- programme includes dedicated bimetallic overload protection relay with a differential mechanism for sensitivity to phase-loss conditions.

Ordering

Minicontactors CI 5-, for AC and DC coil voltage

Main circuit			I _{th} ⁽²⁾ (AC-1) Open A	I _{the} ⁽³⁾ (AC-1) Encl. A	Main contacts number	Built-in auxiliary contacts Number/ Function	Code no. ⁽¹⁾	Type
U _e 230-240 V kW	U _e 400-690 V kW	I _e A						
-	-	-	10 ⁽⁴⁾	6 ⁽⁴⁾	-	4 NO	037H3500	CI 5-2 40E ⁽⁴⁾
-	-	-	10 ⁽⁴⁾	6 ⁽⁴⁾	-	2 NO, 2 NC	037H3501	CI 5-2 22Z ⁽⁴⁾
1.5	2.2	4.9	20	16	3	1 NO	037H3502	CI 5-5 10
1.5	2.2	4.9	20	16	3	1 NC	037H3503	CI 5-5 01
3.0	4.0	8.5	20	16	3	1 NO	037H3504	CI 5-9 10
3.0	4.0	8.5	20	16	3	1 NC	037H3505	CI 5-9 01
3.0	4.0	8.5	20	16	4	-	037H3506	CI 5-9 M40
3.0	5.5	11.5	20	16	3	1 NO	037H3507	CI 5-12 10
3.0	5.5	11.5	20	16	3	1 NC	037H3508	CI 5-12 01

¹⁾ Coil voltage/frequency or Suffix no. (see table below) must be added to the Danfoss code no.

²⁾ The thermal current value I_{th} gives the maximum load at 40°C, which corresponds to installing the contactor in air (open).

³⁾ The thermal current value I_{the} gives the maximum load at 60°C, corresponding installing the contactor inside an enclosure.

⁴⁾ Control relay, rating according to AC-12 category

AC coil voltages for CI 5-

Coil voltage ¹⁾	Suffix no.
24 V, 50/60 Hz	13
110 V, 50 Hz 120 V, 60 Hz	23
230 V, 50/60 Hz	32
240 V, 50/60 Hz	33
400 V, 50/60 Hz	37

¹⁾ Standard coil voltage tolerance -15%, +10%

Correct ordering of contactors

Example: CI 5-5 with NC auxiliary contact and 24 V, 50/60 Hz coil voltage.

Select the following form of ordering:

1. Danfoss code no. + Suffix no.:

037H350313

DC coil voltages for CI 5-

Coil voltage ¹⁾	Suffix no.
*12 V DC	01
24 V DC	02

¹⁾ Standard coil voltage tolerance -30%, + 25%

* Code no. **037H3504** only



Auxiliary contact CBN

Auxiliary contact blocks CI 5-

Contact function	Load				Code no.	Type
	I_e (AC - 15) A	$I_{th}^{(*)}$ (AC - 1) A	$I_{the}^{(*)}$ (AC - 1) A	U_e V		
4 make (NO)	2	10	6	500	037H3511	CBN 40
2 break (NC)	2	10	6	500	037H3513	CBN 02
1 make (NO) + 1 break (NC)	2	10	6	500	037H3514	CBN 11
2 make (NO) + 2 break (NC)	2	10	6	500	037H3515	CBN 22
4 break (NC)	2	10	6	500	037H3512	CBN 04

*) I_{th} and I_{the} are defined and specified under Technical data

CBN mirror contact block ensures reliable monitoring of the status of the CI 5 contactor according to IEC 60947-4-1.

Bifurcated, H-shaped CBN contacts provide outstanding contact reliability for low energy switching down to 15V/2mA.

Accessories for minicotators CI 5-



Mechanical interlock



RC element RCN



Clip-on timer ETN-ON



Base for ETN-ON

Description	Comments	Code no.
Mech. interlock	For interlocking of two adjacent contactors (Applies to versions with AC/DC coils)	037H3520
Diode element	Reduce over voltage on the de-energization of coils type DCN 250 (12...250 V DC)	037H3510
RC element	Reduce over voltage on de-energization of coils type RCN 48 (24...48 V AC)	037H3518
	RCN 280 (110...280 V AC)	037H3519
Clip-on timer	Clip-on timer (ON-delay) - 10 pcs Time range 1 - 30s, voltage range 110-250 V AC/ DC	037H3516*
DIN-rail base for ETN-ON	For DIN rail mounting of clip-on timer ETN-ON, suitable for 35mm DIN rail, 10 pcs.	037H3517*

*Clip-on timer ETN-ON (037H3516) and base for ETN-ON (037H3517) will be available from 2011. Until then we recommend Clip-on timer ETM-ON (037H3153) and base for ETM-ON (037H3154).

Introduction



Thermal overload relay TI 9C-5 is used with mini-contactor CI 5 – for protection of squirrel cage motors where compactness is required. The relay have single – phase protection, i.e. accelerated release if phase drop-out occurs.

This is particularly important for motors with delta connected windings.

Other features of TI 9C-5 :

- stop/ reset button
- manual/automatic reset
- test button
- double scale for direct start or Y/D start
- galvanically isolated signal contact

Ordering

Range		Max. fuse ¹⁾				HRC ²⁾ Form II	Code no.	Type
Motor starter A	Y/D- starter A	gl, gL, gG		BS 88, type T				
		type 1 A	type 2 A	type 1 A	type 2 A			
0.13 - 0.20	-	25	-	32	-	1	047H3130	TI 9C-5
0.19 - 0.29	-	25	-	32	2	1	047H3131	
0.27 - 0.42	-	25	2	32	2	1	047H3132	
0.4 - 0.62	-	25	2	32	4	1	047H3133	
0.6 - 0.92	-	25	4	32	6	3	047H3134	
0.85 - 1.3	-	25	4	32	6	3	047H3135	
1.2 - 1.9	-	25	6	32	10	6	047H3136	
1.8 - 2.8	3.2 - 4.8	25	6	32	10	15	047H3137	
2.7 - 4.2	4.7 - 7.3	25	16	32	20	15	047H3138	
4.0 - 6.2	6.9 - 10.7	35	20	40	25	15	047H3139	
6.0 - 9.2	10 - 16	50	20	50	25	35	047H3140	
8.0 - 12	13 - 20.8	63	25	63	32	35	047H3141	

¹⁾ To IEC 947-4 coordination types 1 and 2:

Coordination type 1: Any type of damage to the motor starter is permissible. If the motor starter is in an enclosure, no external damage to the enclosure is permissible. After a short-circuit the thermal overload relay shall be partially or wholly replaced.

Coordination type 2: No damage to the motor starter is permissible, but slight contact burning and welding is permissible.

²⁾ In accordance with HRC form II, TI 9C and TI 12C is suitable for operation in Canada and the USA.

Selection of thermal overload relay:

The selection of a thermal overload relay must be based on the motor full load current and the method of starting:

- With direct start range for motor starter is used.
- With star – delta start the range for Y/D starter is used.

Example:

Full load current: 12A

- With direct start the suitable motor starter range is 8.0 – 12A, i.e. thermal overload relay 047H3141
- With Y/D – start, the suitable motor starter range is 10 – 16A, i.e. thermal overload relay 047H3140

Construction standards

Contactors, thermal overload relays and accessories are designed and tested in accordance with IEC 60974/EN 60947 and 60068. Max. installation height: 2000 m NN, in accordance with IEC 60947

Mechanically linked contacts IEC 60947-5-1, Annex L	CI 5-5, -9, -12
Mirror contacts IEC 60947-4-1, Annex F	CI 5-5, -9, -12 and CBN

CI 5- General data

Rated impulse voltage withstand U_{imp} [kV]	Rated isolation voltage U_i	
	IEC [V]	UL, CSA [V]
6	690	600

Ambient temperature

Type	Ambient temperature	
	Operation	Storage/Transport
CI 5-	-25°C ... +60°C	-55°C ... +80°C

Vibration and shock

Tested and passed in accordance with IEC 68-2 / EN 60068

Type	Vibration ¹⁾	Shock ²⁾
CI 5-	5g, 5 - 500 Hz	5g, 30ms

¹⁾ Operating conditions: All directions with de-energized coil.

²⁾ Operating conditions: Parallel with armature and with de-energized coil

Environment

Type	Temperature compensated	Ambient temperature	Vibration	Shock perpendicular to contact system	Max. operations per hour
TI 9C-5	-5 ... +40 °C	-50 ... +60 °C	2 g at 200 Hz	9 g for 7.5 ms	30

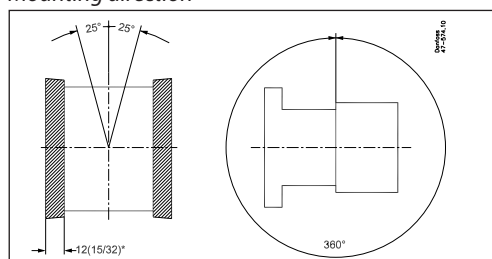
Mounting direction

Rated life

Type	Mechanical life	Electrical life AC-3 load Operations	Electrical life AC-15 load Operations	Switching per hour AC-3 load Operations
CI 5-2	15 x 10 ⁶	-	0.7 x 10 ⁶	-
CI 5-5 CI 5-9 CI 5-12	15 x 10 ⁶	0.7 x 10 ⁶	-	600

Approvals and standards

UL approvals :

CI 5- : cULus Standards UL 508, CSA C22.2 No. 14
 TI 9C-5 : cULus Standards UL 508, CSA C22.2 No. 14 M91

CE IEC/EN 60947-1, -4-1, -5-1, -5-4

Electrical life curves

Electrical life; $U_e = 400 \dots 460V$ AC

AC-3: Switching of squirrel-cage motors while starting.

AC-1: Non- or slightly inductive loads, resistance furnaces.

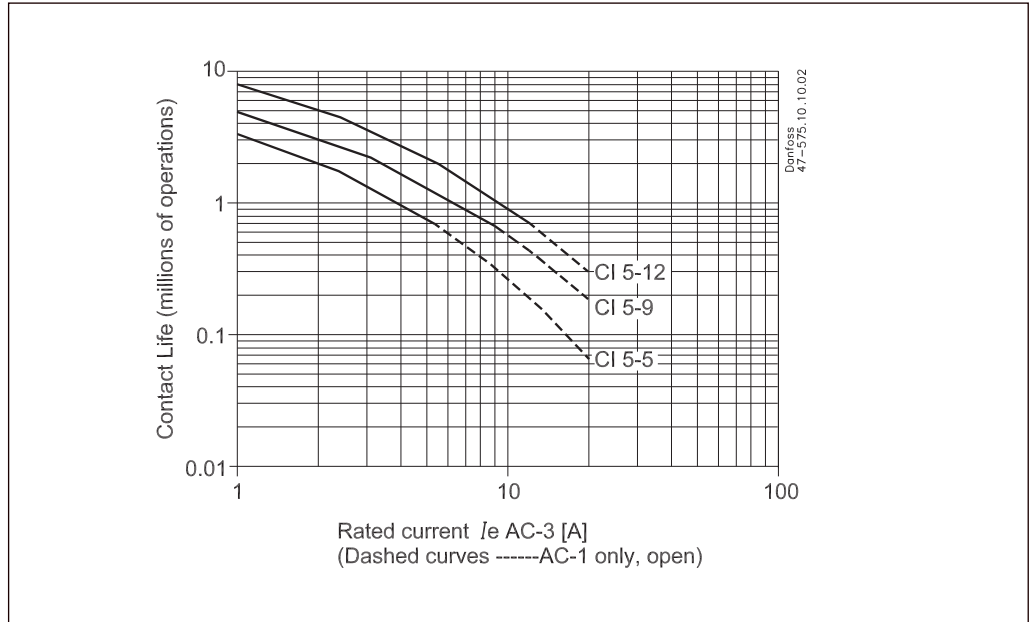

Electrical life; $U_e = 400 \dots 460V$ AC

AC-4: Stepping of squirrel-cage motors

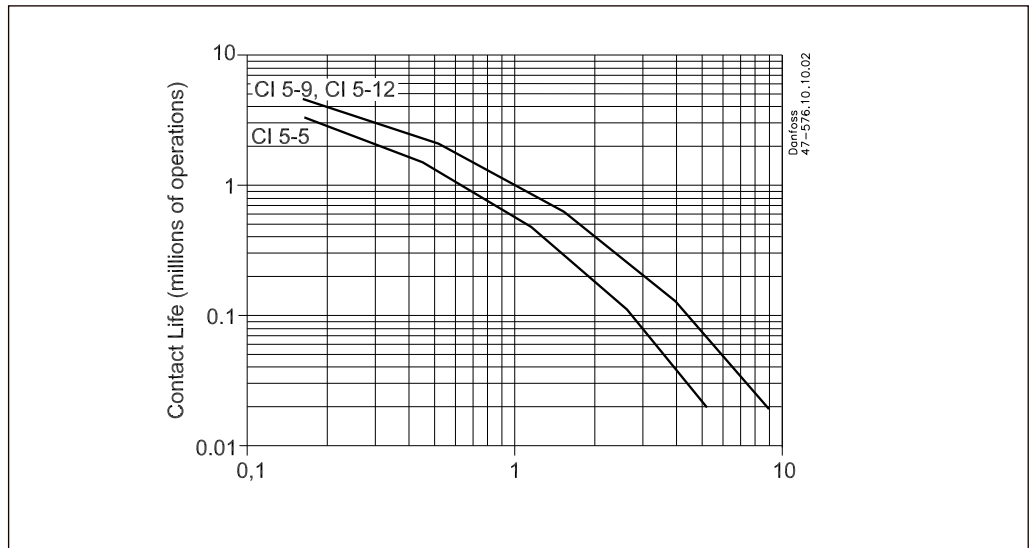

Tripping graph

TI 9C-5

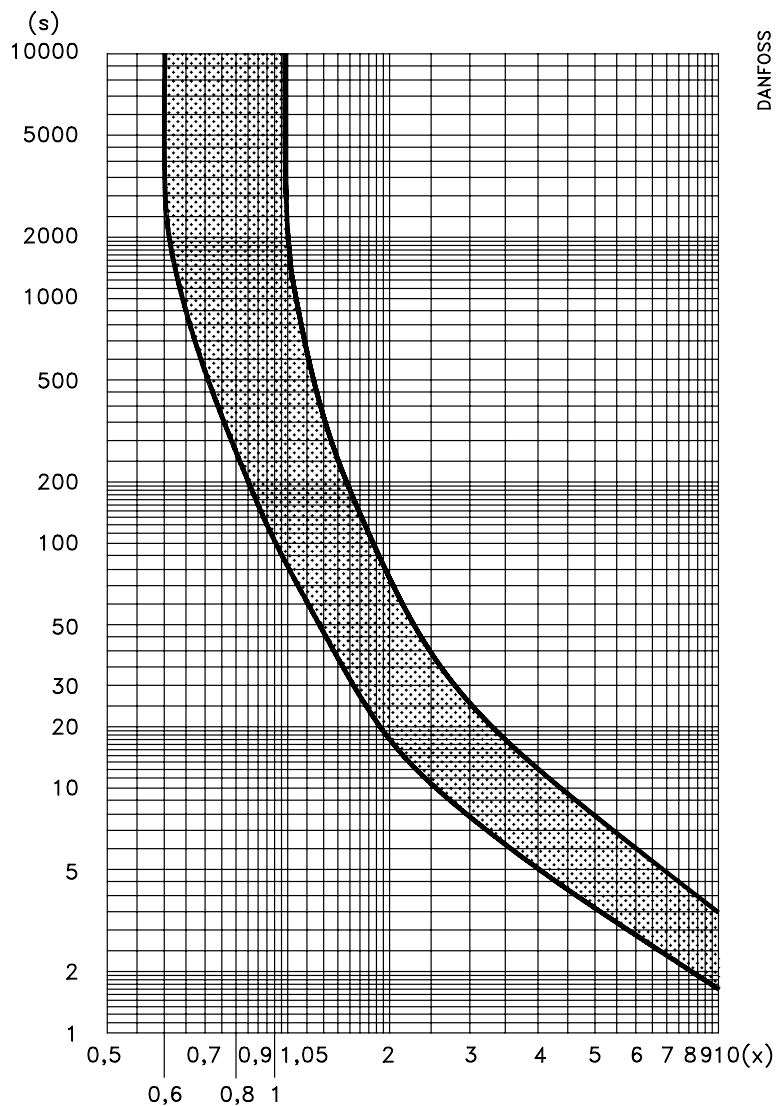
 DANFOSS
A47-392.12

3-phase overload

- 1) Measure overload current
- 2) Find the overload factor (x) by dividing the measured value by the set value of the thermal overload relay (motor full load current).
- 3) Find (x) on the horizontal axis and follow a line vertically up until it intersects the upper curve.
- 4) From the intersection point, follow a horizontal line to the left and read off on the vertical axis the time that will elapse before the thermal overload relay cuts out the motor.

Explanation of graphs

Mean value curves

Upper curve: 3-phase tripping and asymmetric load tripping at min. setting.

Lower curve: Asymmetric load tripping at max. setting.

When tripping from the operationally warm condition, the tripping times are approx. 30% of the values shown. These values apply at an ambient temperature = 20°C.

$$\text{3-phase tripping: } x = \frac{\text{measured current}}{\text{rated motor current}}$$

$$\text{Asymmetric load tripping: } x = \frac{\text{measured current}}{\text{max. scale value on overload relay}}$$

 Tripping time $2 < T_p \leq 10$ s at $7.2 \times I_e$ class 10 A

Note! In general, the thermal overload relay is always set on motor full load current.

Asymmetric load tripping

- 1) Measure the current the motor draws from one of the intact phases.
- 2) Find the overload factor (x) by dividing the measured value by the maximum scale value of the thermal overload relay.
- 3) Find (x) on the horizontal axis and follow a line vertically up until it intersects the lower curve.
- 4) From the intersection point, follow a horizontal line to the left and read off on the vertical axis the time that will elapse before the thermal overload relay switch off the motor.

Contact symbols and control relays terminal markings

Auxiliary contacts

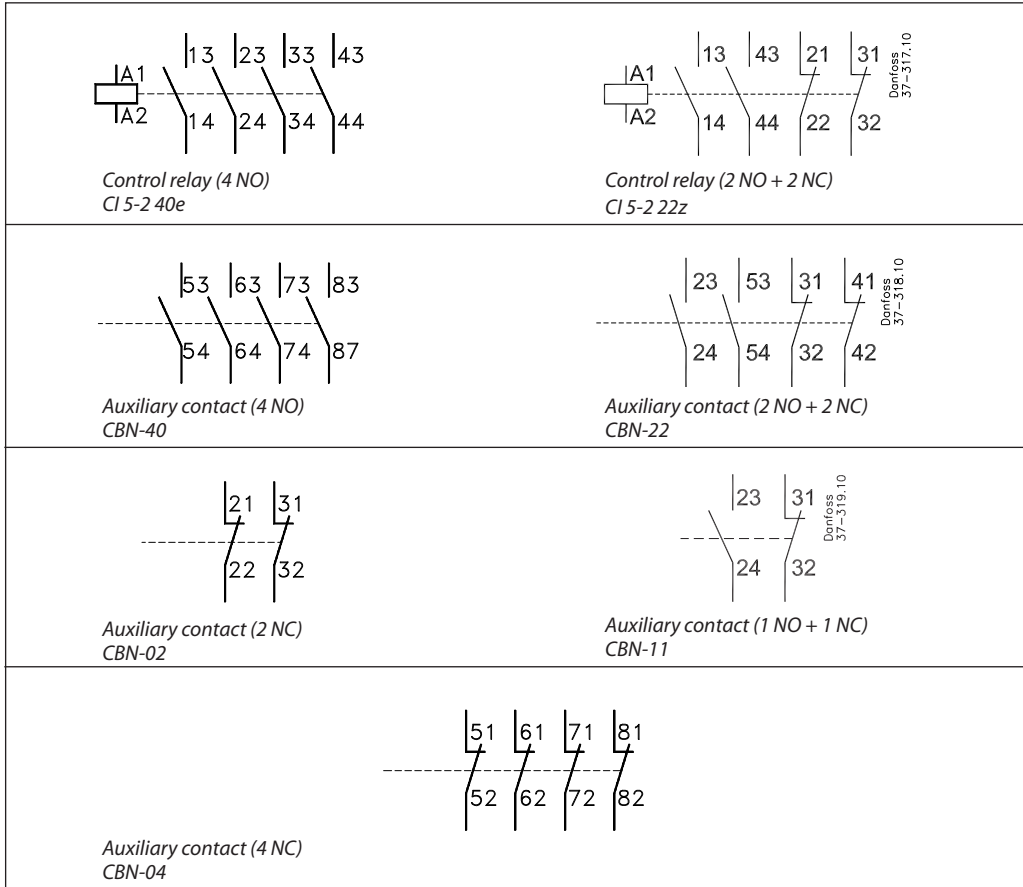

Contactors

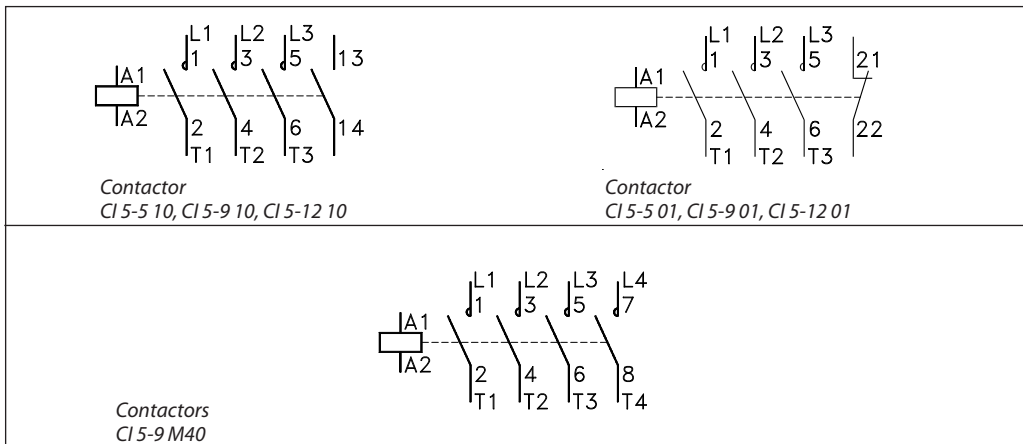

Thermal overload relay

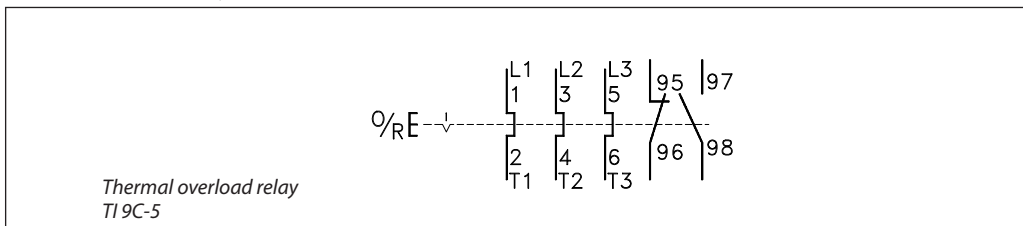

Main circuit

Connections, main contacts

Type	Connection method	Single core [mm ²] / [AWG]	Multi core		Recommended Tightening torque [Nm] / [lb-in]
			without terminal sleeve [mm ²]	with terminal sleeve [mm ²]	
CI 5-	Screw ¹⁾ and clamp washer	1-4 / 18-12	-	0.75-2.5	1.2 / 10.6
TI 9C-5	Screw ²⁾ and clamp washer	0.75 - 4	0.75 - 4	1 - 4	0.8 - 2

¹⁾ Pozidrive No. 2 / Blade No. 3 screw

²⁾ H2 screw

Direct start, load categories AC-2, AC-3, AC-4

Type		Rated loads at 50Hz, 60°C			
		230-240 V	400-415 V	500 V	690 V
CI 5-5	A	6.3	4.9	3.9	2.8
	kW	1.5	2.2	2.2	2.2
CI 5-9	A	11.3	8.5	6.8	4.9
	kW	3	4	4	4
CI 5-12	A	11.3	11.5	9.2	6.7
	kW	3	5.5	5.5	5.5

Load category AC-4 at approximately 200,000 operations

Type		Rated loads		
		230-240 V	400-415 V	500 V
CI 5-5	A	2.3	2	1.9
	kW	0.37	0.75	0.75
CI 5-9	A	3.9	3.6	3.2
	kW	0.75	1.5	1.5
CI 5-12	A	3.9	3.6	3.2
	kW	0.75	1.5	1.5

Star-delta starting

Type		Rated loads at 50 Hz			
		230-240 V	400-415 V	500 V	690 V
CI 5-5	A	11.3	8.5	6.8	4.9
	kW	3	4	4	4
CI 5-9	A	20	15.5	12.4	8.9
CI 5-12	kW	5.5	7.5	7.5	7.5

Three phase ohmic load, load category AC-1

Type		Operating temperature max 40°C (Open condition)				
		230 V	240 V	400-415 V	500 V	600 V
CI 5-5	A	20	20	20	20	20
CI 5-9						
CI 5-12	kW	8	8.3	14	17	24

Three phase ohmic load, load category AC-1

Type		Operating temperature max 60°C (Enclosed condition)					
		230 V	240 V	400 V	415 V	500 V	690 V
CI 5-5	A	16	16	16	16	16	16
CI 5-9							
CI 5-12	kW	6.4	6.7	11	12	14	19

Rated thermal current AC-12

Type	Rated thermal current I _{th} [A]					
	Ambient temperature 40°C			Ambient temperature 60°C		
	24...240 V	230...500 V	230...690 V	24...240 V	230...500 V	230...690 V
CI 5-2	10	10	10	6	6	6

Load categories AC-15/B600

Type	Rated current [A]				
	24 V/ 48 V/ 120 V	230 V/ 240 V	400 V	480 V/ 500 V	600 V/ 690 V
CI 5-2	3	2	1.2	1	0.6

Switching of power transformers, AC-6a (50 Hz)

Type	Transformer load, (factor n = 30, inrush current = n × rated transformer current)				
		230-240 V	400 V/ 415 V	500 V	600 V
CI 5-5	A	2.9	2.4	1.8	-
	kV A	1.2	1.7	1.7	2
CI 5-9	A	5.4	4.1	3.2	-
	kV A	2	2.8	2.8	4
CI 5-12	A	5.4	5.4	3.2	-
	kV A	2	3.4	3.4	5

Load categories AC-7a, AC-7b, AC-8a

Type	Max. operating current [A]					
	AC-7a		AC-7b		AC-8a	
	230 V	400 V	230 V	400 V	400 V	500 V
CI 5-5	20	20	6	6	11	10
CI 5-9	20	20	11	11	18	15
CI 5-12	20	20	11	11	18	15

Switching lighting

Type	Incandescent lamps Max. operating current at 230/240 V [A]	Fluorescent lamps AC-5a 220...240 V AC			
		Max. operating current [A] at 40°C		Max capacitance [μF] at expected short-circuit current I _{cc} =	
		open	closed	10 kA	20 kA
CI 5-5	5	18	14.5	750	400
CI 5-9	9				
CI 5-12					

Switching direct current load
Load categories DC-3 and DC-5, contacts connected in series

Type	Max. operating current [A]									
	DC-3, 3 poles in series, 60°C					DC-5, 3 poles in series, 60°C				
	24 V	48/ 60 V	110 V	220 V	440V	24 V	48/ 60 V	110 V	220 V	440 V
CI 5-5	5	4	2	0.8	0.15	5	2	0.6	0.1	-
CI 5-9	9	6	3	1.2	0.2	9	3	1	0.1	-
CI 5-12	9	6	3	1.2	0.2	9	3	1	0.1	-

Switching direct current load
Load categories DC-1 at 60°C, contact connected in series

Type	Max. operating current [A]														
	24 V			48/60 V			110 V			220 V			440 V		
	1-pole	2-poles	3-poles	1-pole	2-poles	3-poles	1-pole	2-poles	3-poles	1-pole	2-poles	3-poles	1-pole	2-poles	3-poles
CI 5-5	6	6	6	4/1	6	6	0.6	4	6	0.2	0.8	3	0.08	0.2	0.4
CI 5-9 CI 5-12	9	9	9	6/1.5	8	9	1	6	9	0.3	1.2	4	0.1	0.3	0.6

Continuous current

Type	General purpose [A]		DC-13/Q600 [A], 1-pole					
	300 V AC	600 V AC	24 V AC	48 V AC	110 V/ 125 V	220 V/ 250 V	400 V/ 440 V	600 V
CI 5-2	5	10	2.3	1	0.55	0.27	0.15	0.1

Power loss
Contact resistance and power losses

Type	Typical impedance per pole [mΩ]	Power losses 3 main poles AC-3/400 V [W]
CI 5-2	6.5	2.6 ¹⁾
CI 5-5	2.2	0.3
CI 5-9 CI 5-12	2.2	0.9

¹⁾ Power losses 4 main poles

Type	Average power	
	Min. setting	Max. setting
TI 9C-5	Typically 2.15 W	Typically 4.87 W

Short circuit coordination

Type	Short circuit coordination (Max. fuse or circuit breaker rating)		
	DIN fuses - gG [A]	Type "1"	Type "2"
CI 5-5	50 kA Available Fault current	35	16
CI 5-9		35	20
CI 5-12		35	20

Control circuit
Connections, auxiliary contacts

Type/ Application	Connection method	Single core [mm ²] / [AWG]	Multi core		Recommended Tightening torque [Nm] / [lb-in]
			without terminal sleeve [mm ²]	with terminal sleeve [mm ²]	
			CI 5- built in	Screw and clamp washer	
CBN for CI 5-	Screw and clamp washer	1...4 / 18...12	-	0.75...2.5	1.2 / 10.6
TI 9C-5	Screw and clamp washer	0.75-2.5	0.75-1.5	0.75...1.5	0.78-1

Auxiliary contacts, load categories AC-15 and AC-12

Type	Comments	Max. operating current [A]								
		AC-15							AC-12	
		24 V - 120 V	240 V	400 V	480 V	500 V	600 V	690 V	40°C	60°C
CI 5-	Built into contact	6	3	1.8	1.5	1.4	1.2	1	10	6
CBN	For contact CI 5-	3	2	1.2	1	1	0.6	0.6	10	6

Auxiliary contacts, load categories DC-12, DC-13, DC-14

Type	Comments	Max. operating current [A]														
		DC-12					DC-13					DC-14				
		12 V	48 V	110 V - 125 V	220 V - 250 V	400 V - 440 V	12 V	48 V	110 V - 125 V	220 V - 250 V	400 V - 440 V	12 V	48 V	110 V - 125 V	220 V - 250 V	400 V - 440 V
CI 5-	Built into contact	6	4	0.6	0.2	0.08	4	2.5	0.4	0.12	0.05	2.8	1.2	0.55	0.27	0.15
CBN	For contact CI 5-	-	-	-	-	-	-	-	-	-	-	2.3	1	0.55	0.27	0.15

Coil consumption

Type	Inrush power				Holding power				Pull-in voltage		Drop-out voltage	
	AC		DC		AC		DC		AC	DC	AC	DC
	VA	W	W	W	VA	W	W	W	V	V	V	V
CI 5-	35	32	3 ¹⁾	2.6 ²⁾	5	1.8	3 ¹⁾	2.6 ²⁾	$(0.85...1.1) \times U_s$	$(0.8...1.1) \times U_s$	$(0.2...0.75) \times U_s$	$(0.1...0.75) \times U_s$

¹⁾ cold

²⁾ warm

Coil operating times

Type	Make time			Break time			
	AC	DC	AC	AC+RC module	DC	DC+integrated diode	DC+external diode
	ms	ms	ms	ms	ms	ms	ms
CI 5-	15...40	18...40	15...33	15...28	6...12	8...12	35...50

RC element (charge suppressor)

Type	Comments	overvoltage factor $n = U_{max} / U_n$
RCN	Suitable for contactors CI 5-	1 - 2.5

Max. load control circuit (contact system)

Type	Load		Max. fuse	
	AC-15	DC-13	fI, gL, gG	Bs 88 type T
	TI 9C-5	500 V 2 A 200 VA	250 V 2 A 20 W	4A

UL/ CSA specification
UL/CSA approved loads

Type	General purpose current (enclosed)	Rated power (enclosed)												
		1-phase				3-phase								
		115 V			230 V		200 V		230 V		460 V		575 V	
		[A]	[A]	[HP]	[A]	[HP]	[A]	[HP]	[A]	[HP]	[A]	[HP]	[A]	[HP]
CI 5-5	12	9.8	0.5	8	1	6.9	1.5	6	1.5	4.8	3	3.9	3	
CI 5-9	15	9.8	0.5	10	1.5	7.8	2	6.8	2	7.6	5	6.1	5	
CI 5-12	18	13.8	0.75	12	2	11	3	9.6	3	11	7.5	9	7.5	

Star-delta (60 Hz)

Type	Rated power [HP]			
	200 V	230 V	460 V	575 V
CI 5-5	2.5	2.5	5	5
CI 5-9	3.3	3.3	8.5	8.5
CI 5-12	5	5	12	12

Auxiliary contacts, UL/CSA approved loads

Type	Comments	AC		DC	
		Rated voltage [V]	Switching capacity [A]	Rated voltage [V]	Switching capacity [A]
CI 5-2	Built into contact	max. 600	B600	max. 600	Q600
CI 5, 9, 12	Built into contact	max. 600	A600	max. 600	Q600
CBN	For contact CI 5-	max. 600	B600	max. 600	Q600

Dimensions

Contactor CI 5-

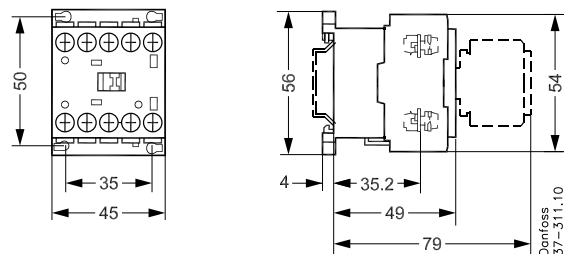

Motor starter CI 5- +TI 9C-5

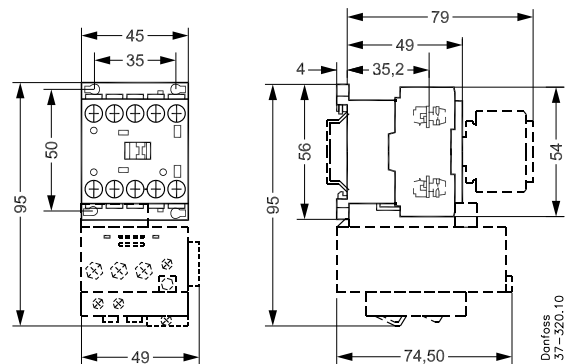

Danfoss can accept no responsibility for possible errors in catalogues, brochures and other printed material. Danfoss reserves the right to alter its products without notice. This also applies to products already on order provided that such alterations can be made without consequential changes being necessary in specifications already agreed. All trademarks in this material are property of the respective companies. Danfoss and the Danfoss logotype are trademarks of Danfoss A/S. All rights reserved.